

**Features**

- High current gain

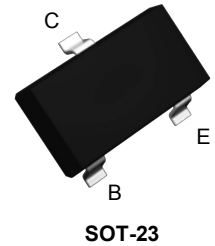

**Absolute Maximum Ratings**

( $T_A=25^{\circ}\text{C}$  unless otherwise noted)

Parameter	Symbol	Value	Unit
Collector-Base Voltage	$V_{CB0}$	80	V
Collector-Emitter Voltage	$V_{CE0}$	80	V
Emitter-Base Voltage	$V_{EB0}$	12	V
Collector Current	$I_C$	500	mA
Collector Power Dissipation	$P_C$	200	mW
Thermal Resistance From Junction To Ambient	$R_{\theta JA}$	625	$^{\circ}\text{C}/\text{W}$
Junction Temperature	$T_J$	-55 to +150	$^{\circ}\text{C}$
Storage Temperature	$T_{STG}$	-55 to +150	$^{\circ}\text{C}$

**Electrical Characteristics** ( $T_A=25^{\circ}\text{C}$  unless otherwise noted)

Parameter	Symbol	Test Conditions	Min	Max	Unit
Collector-Base Breakdown Voltage	$V_{(BR)CBO}$	$I_C=100\mu\text{A}, I_E=0$	80	-	V
Collector-Emitter sustain Voltage	$V_{CE0(sus)}$	$I_C=100\mu\text{A}, V_{BE}=0$	80	-	V
Emitter-base Breakdown Voltage	$V_{(BR)EBO}$	$I_E=10\mu\text{A}, I_C=0$	12	-	V
Collector Cut-off Current	$I_{CBO}$	$V_{CB}=60\text{V}, I_E=0$	-	0.1	$\mu\text{A}$
Collector Cut-off Current	$I_{CES}$	$V_{CE}=60\text{V}, V_{BE}=0$	-	0.5	$\mu\text{A}$
Emitter Cut-off Current	$I_{EBO}$	$V_{EB}=10\text{V}, I_C=0$	-	0.1	$\mu\text{A}$
DC Current Gain	$h_{FE(1)}^*$	$V_{CE}=5\text{V}, I_C=10\text{mA}$	10	-	K
	$h_{FE(2)}^*$	$V_{CE}=5\text{V}, I_C=100\text{mA}$	10	-	K
Collector-Emitter Saturation Voltage	$V_{CE(sat)1}^*$	$I_C=10\text{mA}, I_B=0.01\text{mA}$	-	1.2	V
	$V_{CE(sat)2}^*$	$I_C=100\text{mA}, I_B=0.1\text{mA}$	-	1.5	V
Base-Emitter Voltage	$V_{BE}^*$	$V_{CE}=5\text{V}, I_C=100\text{mA}$	-	2	V
Collector Output Capacitance	$C_{ob}$	-	-	8	pF
Transition Frequency	$f_r$	$V_{CE}=5\text{V}, I_C=10\text{mA}, f=100\text{MHz}$	125	-	MHz

\*Pulse test: pulse width  $\leq 300\mu\text{s}$ , duty cycle  $\leq 2.0\%$ .

**Typical Electrical Characteristic Curves**

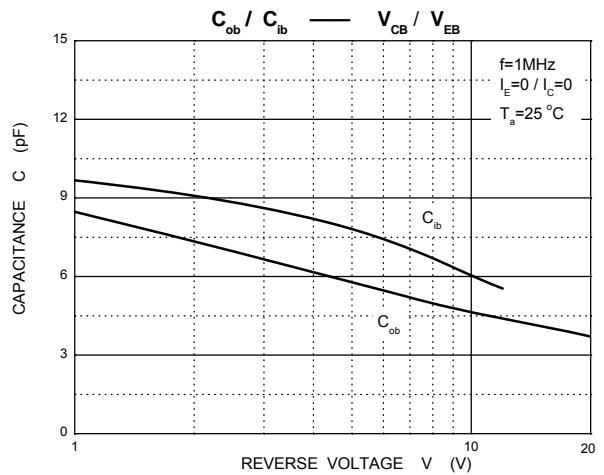
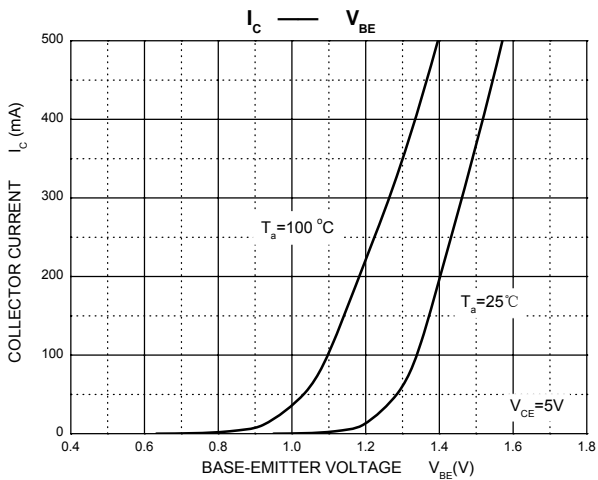
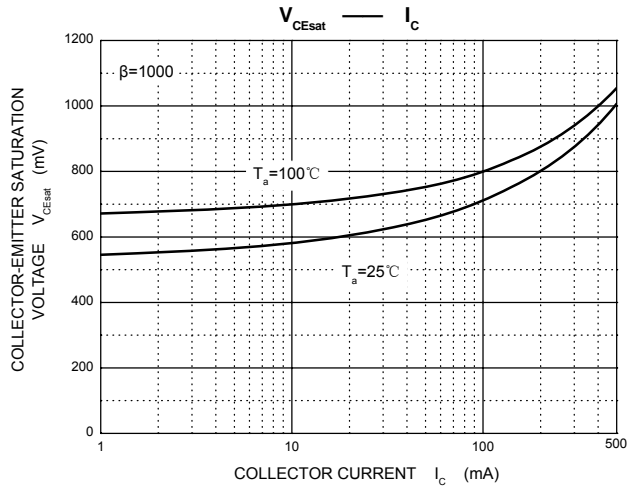
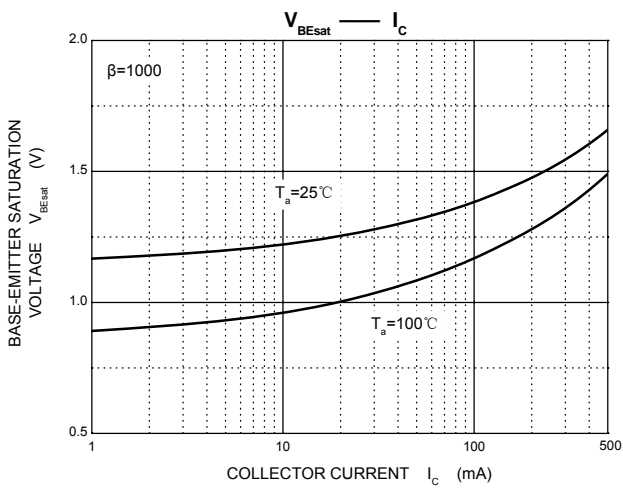
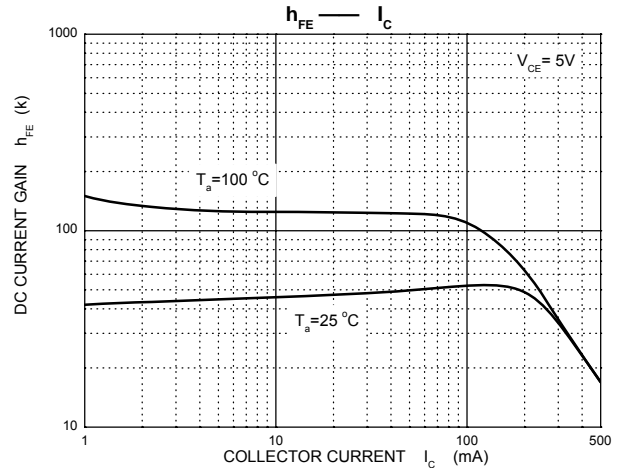
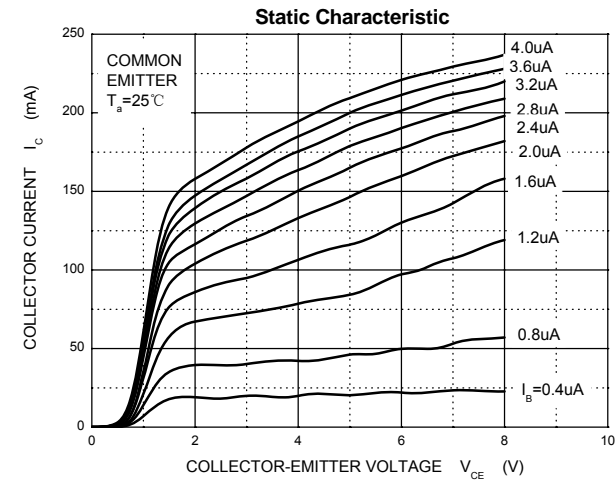

### Typical Electrical Characteristic Curves

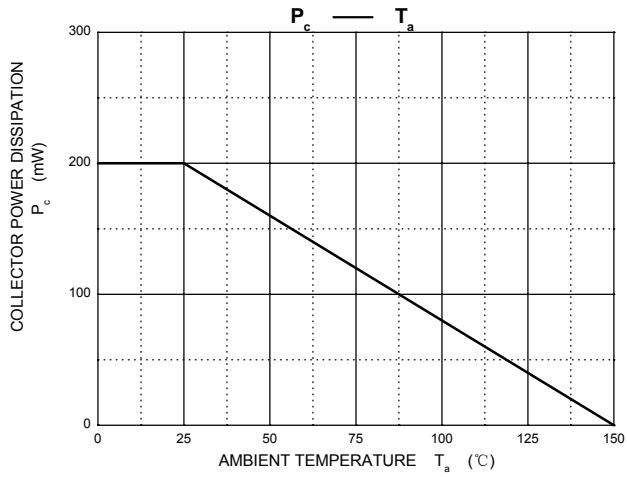

**Package Outline Dimensions**

SOT-23

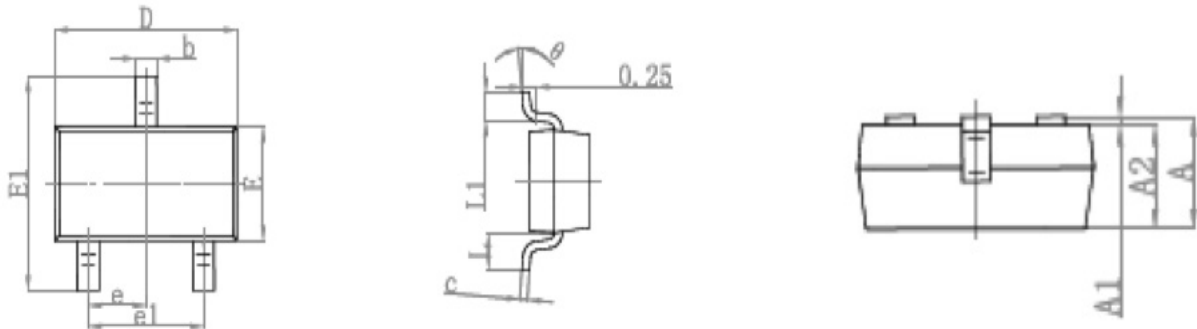

Symbol	Dimensions In Millimeters		Dimensions In Inches	
	Min.	Max.	Min.	Max.
A	0.900	1.150	0.035	0.045
A1	0.000	0.100	0.000	0.004
A2	0.900	1.050	0.035	0.041
b	0.300	0.500	0.012	0.020
c	0.080	0.150	0.003	0.006
D	2.800	3.000	0.110	0.118
E	1.200	1.400	0.047	0.055
E1	2.250	2.550	0.089	0.100
e	0.950 TYP.		0.037 TYP.	
e1	1.800	2.000	0.071	0.079
L	0.550 REF.		0.022 REF.	
L1	0.300	0.500	0.012	0.020
θ	0°	8°	0°	8°

**Suggested Pad Layout**

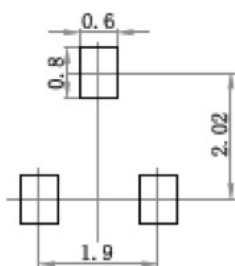

- Note:
1. Controlling dimension: in millimeters.
  2. General tolerance:  $\pm 0.05\text{mm}$ .
  3. The pad layout is for reference purposes only.