

Features

- Fast switching speed
- For general purpose switching applications
- High conductance
- Low reverse leakage

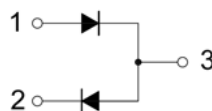

Schematic Diagram

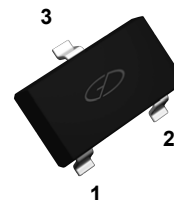

SOT-23



Maximum Ratings ($T_A=25\text{ }^\circ\text{C}$ unless otherwise noted)

Parameter	Symbol	Value	Unit
Repetitive Reverse Voltage	V_{RRM}	100	V
Reverse Voltage	V_R	100	V
Forward Current (Single Diode)	I_F	420	mA
Forward Current (Double Diode)		300	
Non-Repetitive Peak Forward Surge Current, @ $T_P=1.0\mu\text{s}$	I_{FSM}	9.0	A
Non-Repetitive Peak Forward Surge Current, @ $T_P=1.0\text{ms}$		3.0	
Non-Repetitive Peak Forward Surge Current, @ $T_P=1.0\text{s}$		1.0	
Repetitive Peak Forward Current	I_{FRM}	900	mA
Power Dissipation	P_D	300	mW
Thermal Resistance, Junction-to-Ambient	$R_{\theta JA}$	430	$^\circ\text{C/W}$
Operating Junction Temperature Range	T_J	-55 To +150	$^\circ\text{C}$
Storage Temperature Range	T_{STG}	-55 To +150	$^\circ\text{C}$

Electrical Characteristics ($T_A=25^\circ\text{C}$ unless otherwise specified)

Parameter	Symbol	Conditions	Min.	Max.	Unit
Reverse Breakdown Voltage	V_R	$I_R=100\mu\text{A}$	100	-	V
Forward Voltage	V_F	$I_F=1\text{mA}$	-	0.72	V
		$I_F=10\text{mA}$	-	0.86	
		$I_F=50\text{mA}$	-	1	
		$I_F=150\text{mA}$	-	1.2	
		$I_F=300\text{mA}$	-	1.25	
Reverse Current	I_R	$V_R=25\text{V}$	-	30	nA
		$V_R=100\text{V}$	-	1	μA
		$V_R=25\text{V}, T_J=150^\circ\text{C}$	-	30	
		$V_R=100\text{V}, T_J=150^\circ\text{C}$	-	60	
Capacitance Between Terminals	C_T	$V_R=0, f=1\text{MHz}$	-	3	pF
Reverse Recovery Time	t_{rr}	$I_F=I_R=10\text{mA},$ $R_L=100\Omega, I_{RR}=0.1 \times I_R$	-	6	ns
Forward Recovery Voltage	V_{FR}	$I_F=10\text{mA}, t_r=20\text{ns}$	-	1.75	V

Ratings and Characteristic Curves ($T_A=25^\circ\text{C}$ unless otherwise specified)

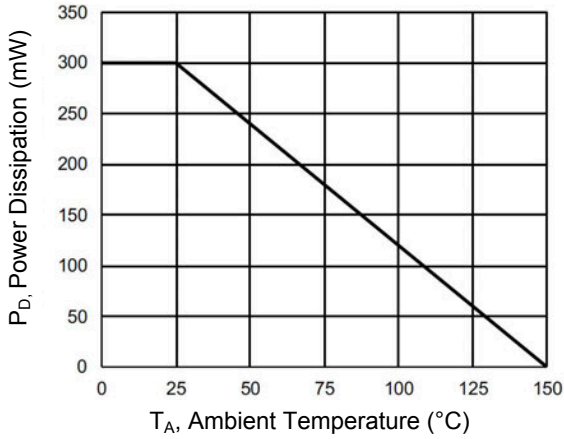

Figure 1. Power Derating Curve

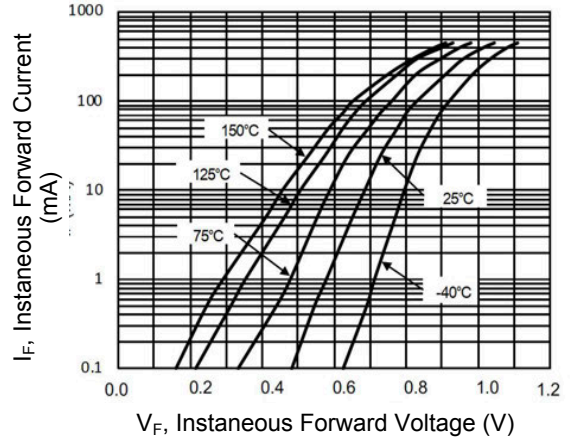

Figure 2. Forward Characteristics

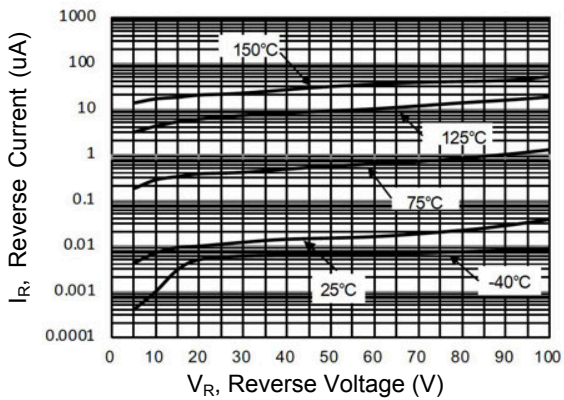

Figure 3. Reverse Characteristics

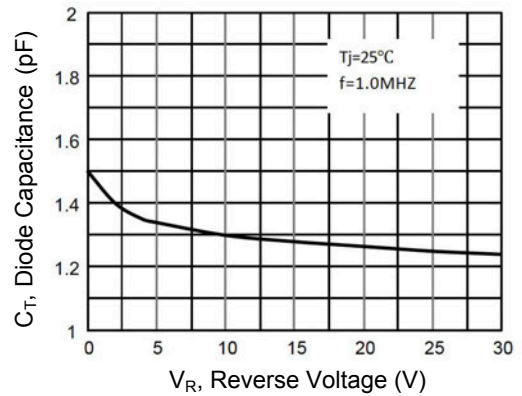
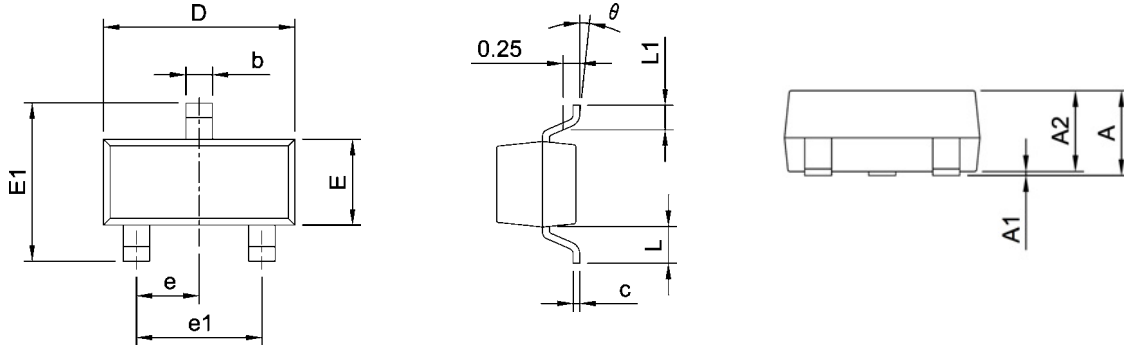

Figure 4. Capacitance Characteristics

Package Outline Dimensions (SOT-23)



Symbol	Dimensions In Millimeters		Dimensions In Inches	
	Min	Max	Min	Max
A	0.900	1.150	0.035	0.045
A1	0.000	0.100	0.000	0.004
A2	0.900	1.050	0.035	0.041
b	0.300	0.500	0.012	0.020
c	0.080	0.150	0.003	0.006
D	2.800	3.000	0.110	0.118
E	1.200	1.400	0.047	0.055
E1	2.250	2.550	0.089	0.100
e	0.950 TYP		0.037 TYP	
e1	1.800	2.000	0.071	0.079
L	0.550 REF		0.022 REF	
L1	0.300	0.500	0.012	0.020
θ	0°	8°	0°	8°

Recommended Pad Layout

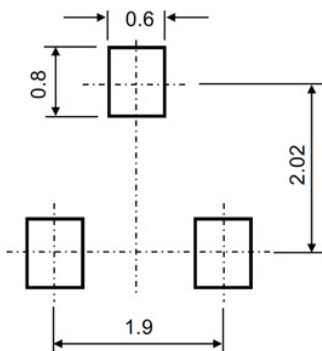

Note:
 1. Controlling dimension: in millimeters.
 2. General tolerance: $\pm 0.05\text{mm}$.
 3. The pad layout is for reference purposes only.

Order Information

Device	Package	Marking	Carrier	Quantity
BAS299	SOT-23	BA9	Tape & Reel	3,000 pcs / Reel