

SMBR20100S-SMBRF20100S

Schottky Barrier Rectifier
 Reverse Voltage 100 V Forward Current 20 A

Features

- Plastic package has underwriters Laboratory Flammability Classification 94V-0
- Low forward voltage, high efficiency



SMBR20100S
 Package: TO-220-AB



SMBRF20100S
 Package: ITO-220-AB

Mechanical Data

- Case: epoxy, molded
- Weight: 1.9grams (approximately)
- Lead temperature for soldering purpose: 260°C max. for 10 sec
- 50 units per plastic tube

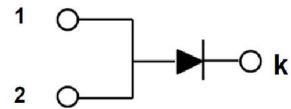

Schematic Diagram

Maximum Ratings & Electrical Characteristics

(T_A=25°C unless otherwise noted)

Parameter	Test Conditions		Symbol	Value	Unit
Maximum Repetitive Peak Reverse Voltage			V _{RRM}	100	V
Working Peak Reverse Voltage			V _{RWM}	100	V
Maximum DC Blocking Voltage			V _{DC}	100	V
Maximum Average Forward Rectified Current @ T _c =105°C	Total Device		I _{F(AV)}	20	A
Peak Forward Surge Current 8.3ms Single Half Sine-wave Superimposed on Rated Load per Diode			I _{FSM}	150	A
Peak repetitive Reverse Current Per Leg at tp=2.0μs ,1KHz			I _{RRM}	1.0	A
Voltage Rate of Change (rated V _R)			DV/dt	10000	V/μs
Operating Junction Temperature Range			T _J	- 55 to+150	°C
Storage Temperature Range			T _{STG}	- 55 to+150	°C
Isolation Voltage (ITO-220-AB only) from Terminal to Heatsink t = 1 sec			V _{AC}	1500	V
Maximum Instantaneous Forward Voltage per Leg	I _F =10A I _F =10A	T _C =25°C T _C =125°C	V _F	0.60 (0.55 typ) 0.50	V
Maximum Reverse Current per Leg at Working Peak Reverse Voltage		T _J =25°C T _J =100°C	I _R	500 50	μA mA
Thermal Characteristics (T_A=25°C unless otherwise noted)					
Symbol	Parameter		Typ.(TO-220-AB)	Typ.(ITO-220-AB)	Unit
R _{θJC}	Thermal Resistance, Junction to Case per Leg		2.0	4.0	°C/W
R _{θJA}	Thermal Resistance, Junction to Ambient per Leg		62.5	62.5	°C/W

Note: Pulse test:300us pulse width, duty cycle=2%

Ratings and Characteristics Curves ($T_A = 25^\circ\text{C}$ unless otherwise noted)

FIG.1- FORWARD CURRENT DERATING CURVE

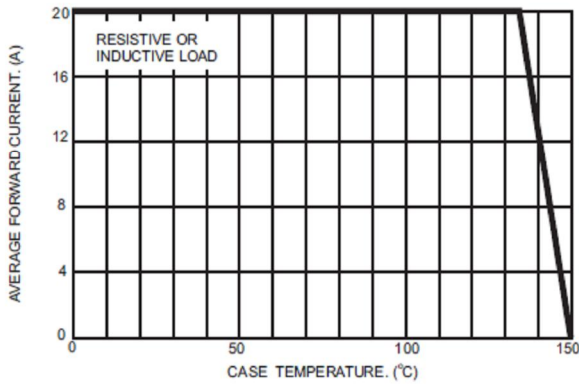

FIG.2- MAXIMUM NON-REPETITIVE FORWARD SURGE CURRENT PER LEG

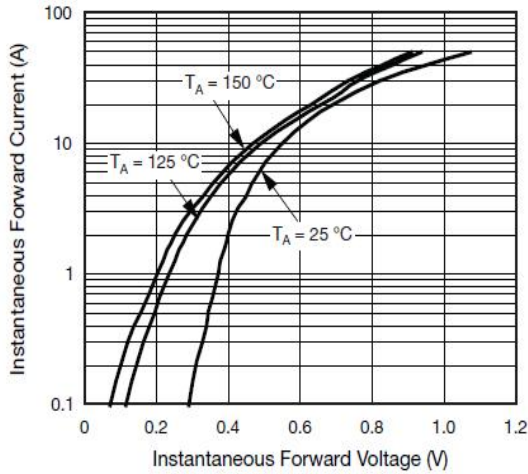
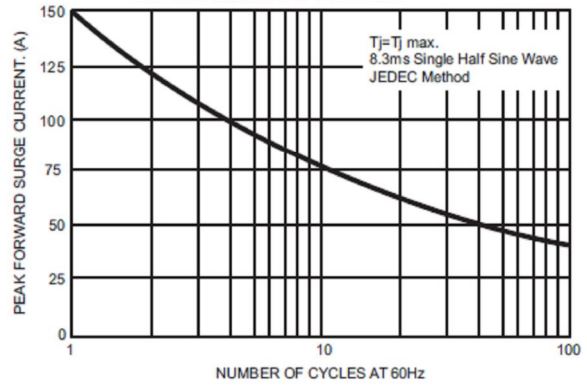

Fig. 3 - Typical Instantaneous Forward Characteristics

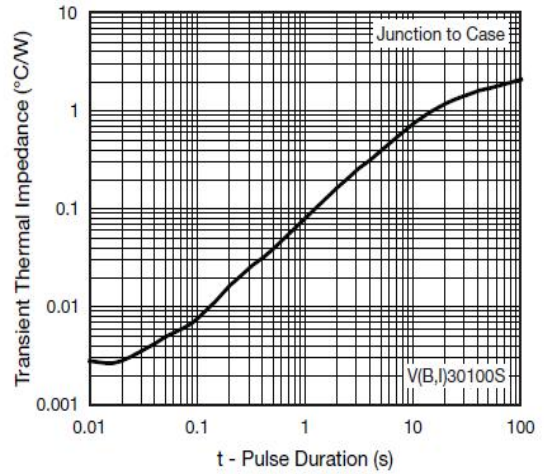

Fig. 6 - Typical Transient Thermal Impedance

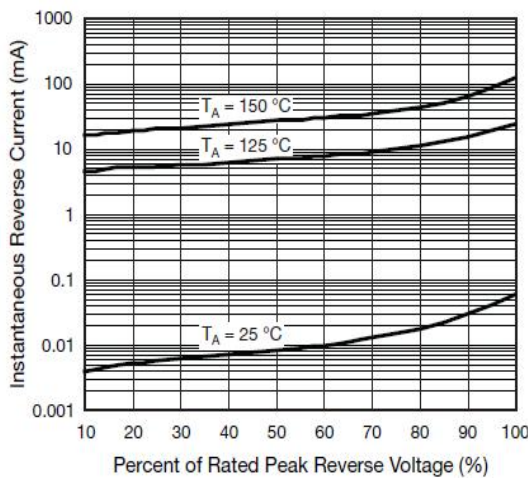

Fig. 4 - Typical Reverse Characteristics

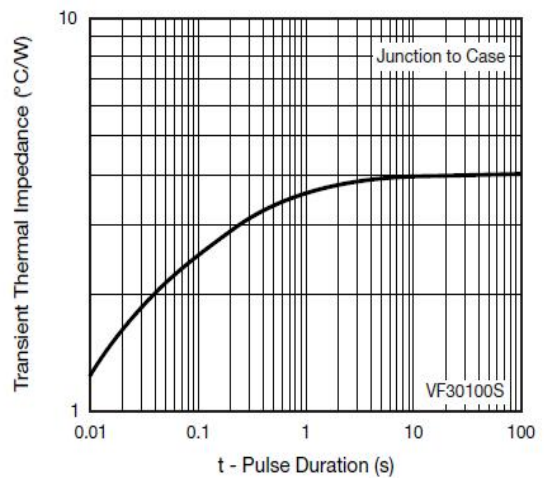
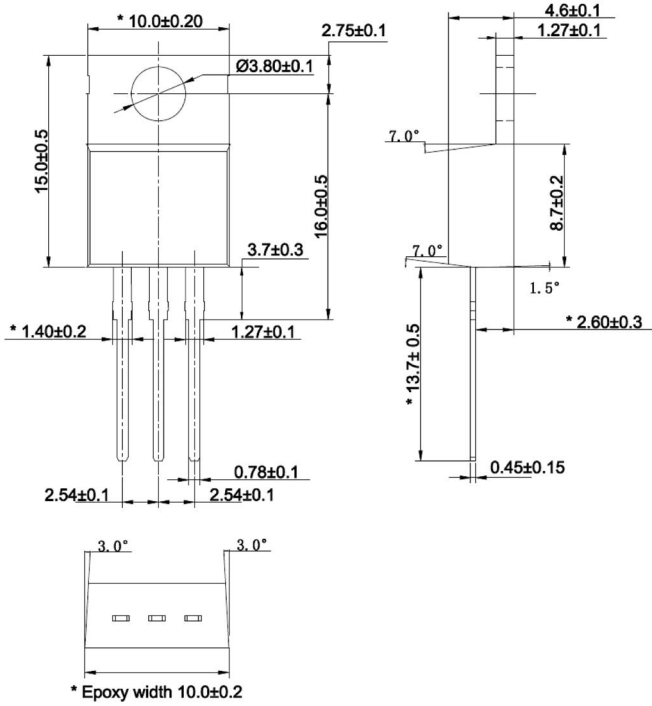

Fig. 7 - Typical Transient Thermal Impedance

Package Outline Dimensions

in millimeters

TO-220-AB



ITO-220-AB

