

Features

- Low forward voltage drop
- High junction temperature
- Moisture sensitivity: level 1, per J-STD-020
- Plastic package has underwriters laboratory flammability classification 94V-0
- Add suffix 'E' for halogen-free
- Halogen-free according to IEC 61249-2-21 definition
- AEC-Q101 qualified



Package: DO-214AA (SMB)

Applications

For use in low voltage, high frequency inverters, free wheeling and polarity protection applications.

Maximum Ratings (T_A = 25°C unless otherwise noted)

Parameter	Symbol	SK32B SK32BE	SK33B SK33BE	SK34B SK34BE	SK35B SK35BE	SK36B SK36BE	Unit
Maximum Repetitive Peak Reverse Voltage	V _{RRM}	20	30	40	50	60	V
Maximum RMS Voltage	V _{RMS}	14	21	28	35	42	V
Maximum DC Blocking Voltage	V _{DC}	20	30	40	50	60	V
Maximum Average Forward Rectified Current	I _{F(AV)}	3.0					A
Peak Forward Surge Current (8.3 ms single half sine-wave superimposed on rated load)	I _{FSM}	50					A
Operating Junction and Storage Temperature Range	T _J , T _{STG}	-55 to +150					°C

Electrical Characteristics (T_A = 25°C unless otherwise noted)

Parameter	Test Conditions	Symbol	SK32B SK32BE	SK33B SK33BE	SK34B SK34BE	SK35B SK35BE	SK36B SK36BE	Unit
Maximum Instantaneous Forward Voltage	I _F =3A	V _F	0.55			0.70		V
Maximum DC Reverse Current at Rated DC Blocking Voltage	T _A =25°C	I _R	0.20			0.15		mA
	T _A =125°C		10					
Typical Junction Capacitance	4.0 V, 1 MHz	C _J	250					pF

Thermal Characteristics

Parameter	Symbol	Value	Unit
Typical Thermal Resistance ⁽¹⁾	R _{θJA}	70	°C/W
	R _{θJC}	28	
	R _{θJL}	15	

Note1: Thermal resistance from junction to lead, mounted on PCB with 8.0×8.0mm copper pads.

Ratings and Characteristics Curves

($T_A = 25^\circ\text{C}$ unless otherwise noted)

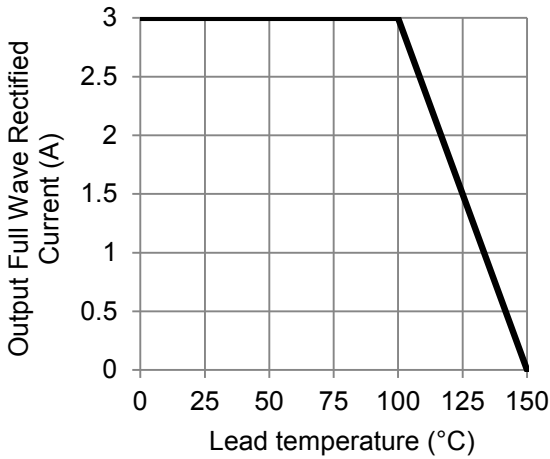

Figure 1. Forward Current Derating Curve

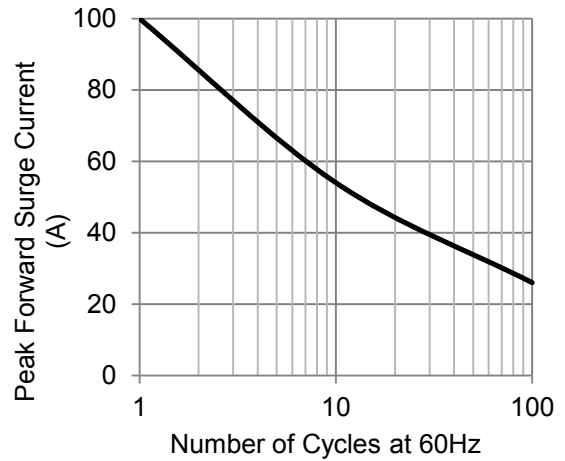

Figure 2. Maximum Non-Repetitive Peak Forward Surge Current

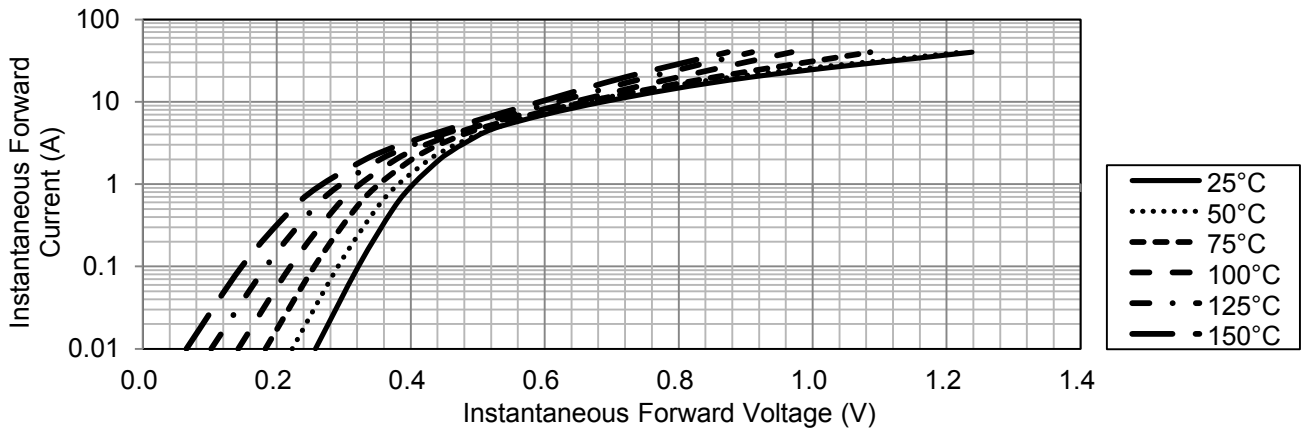

Figure 3. Typical Instantaneous Forward Characteristics (SK32B thru SK34B)

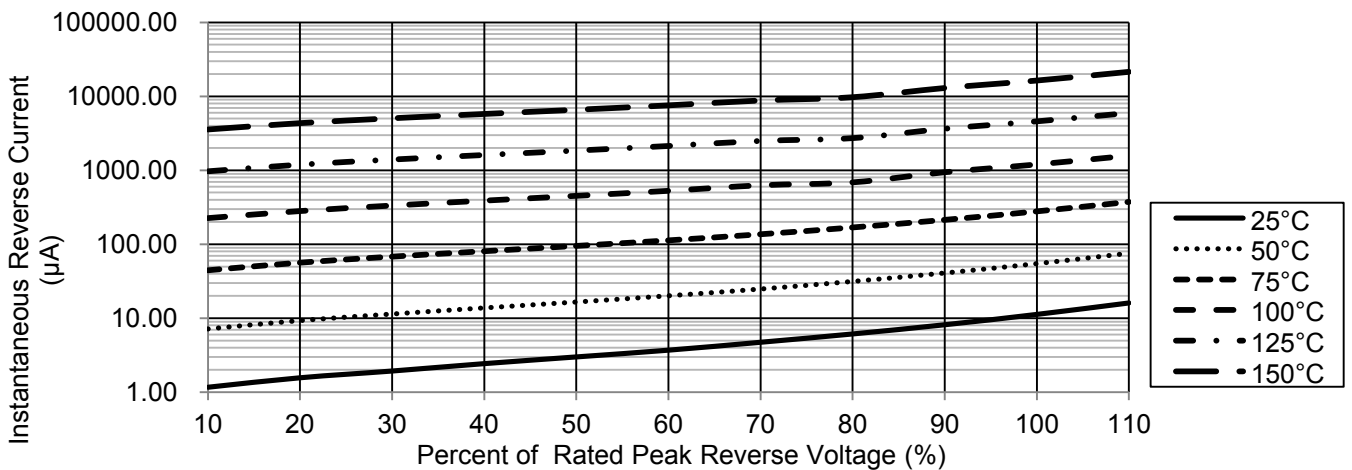

Figure 4. Typical Reverse Characteristics (SK32B thru SK34B)

SK32B thru SK36B

Surface Mount Schottky Rectifier
 Reverse Voltage 20-60V Forward Current 3A

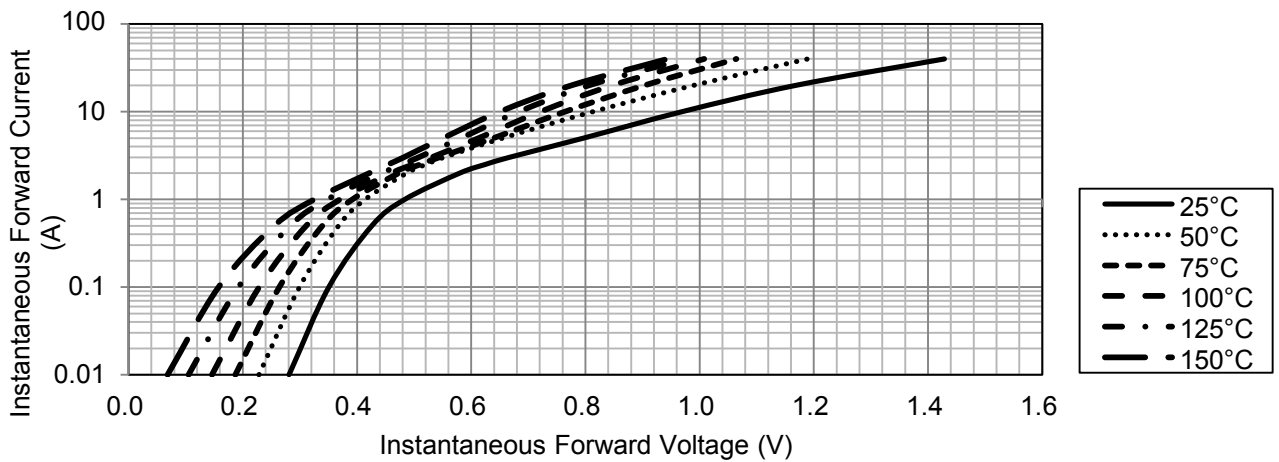

Figure 5. Typical Instantaneous Forward Characteristics
 (SK35B thru SK36B)

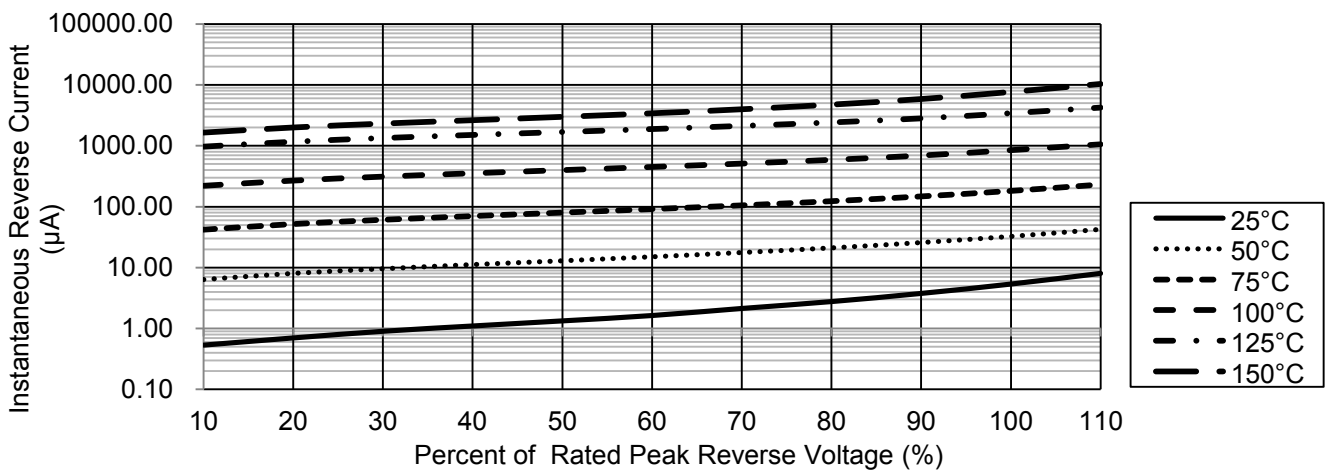

Figure 6. Typical Reverse Characteristics
 (SK35B thru SK36B)

SK32B thru SK36B

Surface Mount Schottky Rectifier
 Reverse Voltage 20-60V Forward Current 3A

Package Outline Dimensions

in inches (millimeters)

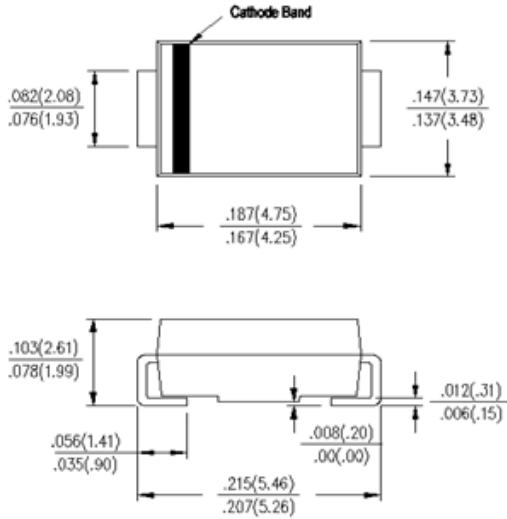

DO-214AA (SMB)

Mounting Pad Layout

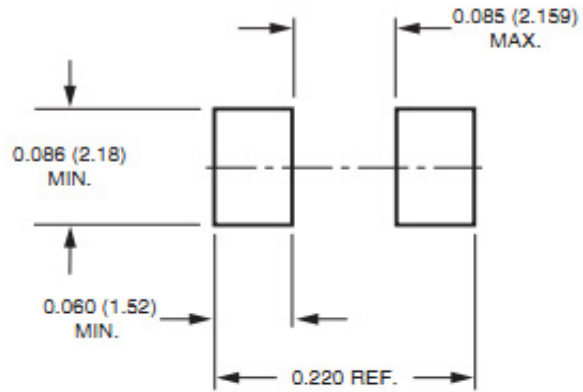

Packing Information

3000 pcs/Reel, 18 Reels/Box, 12mm Tape, 13" Reel

Tape & Reel Specification

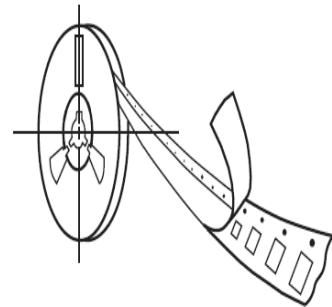
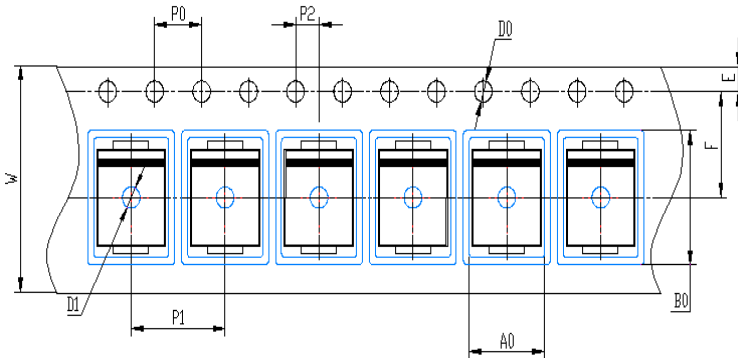

Symbol	SMB(mm)
W	12±0.2
E	1.75±0.1
F	5.5±0.05
D0	1.5±0.1
D1	1.50 +0.1/-0
P0	4.0±0.1
P1	8.0±0.1
P2	2.0±0.05
A0	3.95±0.1
B0	5.74±0.1

Soldering Parameters

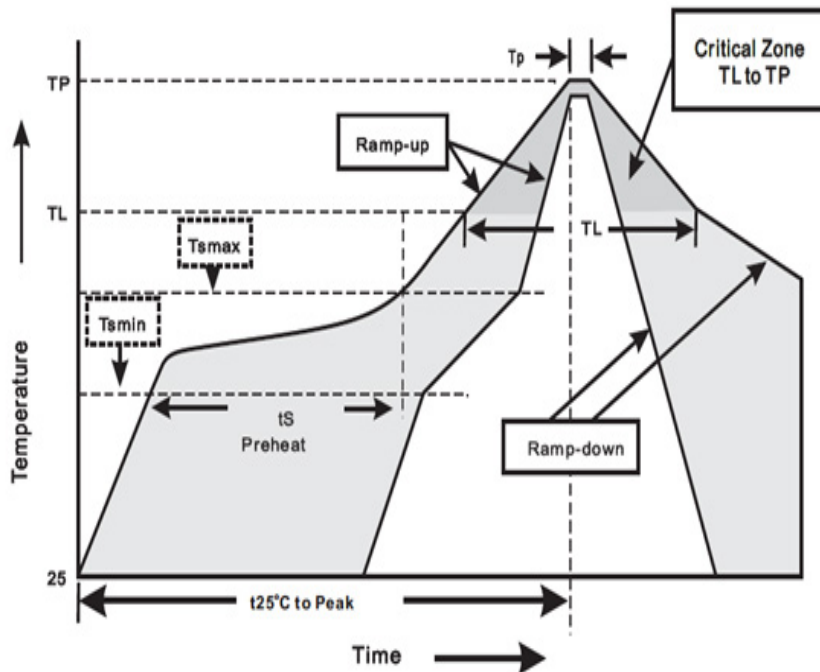

Reflow Soldering		Sn-Pb Eutectic Assembly	Pb-Free Assembly
Pre Heat	- Temperature Min (Ts min)	100°C	150°C
	- Temperature Max (Ts max)	150°C	200°C
	- Time (min to max) (ts)	60 – 120 secs	60 – 180 secs
Average ramp up rate (Liquidus) Temp (TL) to peak		3°C/second max	3°C/second max
TS(max) to TL - Ramp-up Rate		3°C/second max	3°C/second max
Reflow	- Temperature (TL) (Liquidus)	183°C	217°C
	- Time (min to max) (ts)	60 – 150 seconds	60 – 150 seconds
Peak Temperature (TP)		240+0/-5 °C	240+0/-5°C
Time within 5°C of actual peak Temperature (tp)		10 –30 seconds	20 – 40 seconds
Ramp-down Rate		6°C/second max	6°C/second max
Time 25°C to peak Temperature (TP)		6 minutes max	8 minutes max
Do not exceed		260°C	260°C

Wave Soldering	
Peak Temperature	260+0/-5°C
Dipping Time	10 seconds
Soldering	1 time