

Features

- Plastic package has underwriters Laboratory Flammability Classification 94V-0
- Dual rectifier construction, positive center tap
- Low forward voltage, high efficiency
- Guarding for over voltage protection

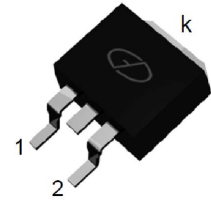

Package: TO-263

Mechanical Data

- Case: epoxy, molded
- Weight: 1.4grams (approximately)
- Lead temperature for soldering purpose: 260°C max. for 10 sec
- 50 units per plastic tube or 800 pcs per reel

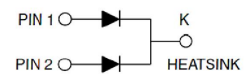

Schematic Diagram

Maximum Ratings & Electrical Characteristics

(T_A=25°C unless otherwise noted)

Parameter	Test Conditions		Symbol	Value	Unit
Maximum Repetitive Peak Reverse Voltage			V _{RRM}	150	V
Working Peak Reverse Voltage			V _{RWM}	150	V
Maximum DC Blocking Voltage			V _{DC}	150	V
Maximum Average Forward Rectified Current @ T _c =105°C	Total Device		I _{F(AV)}	10	A
	Per Diode			5	
Peak Forward Surge Current 8.3ms Single Half Sine-wave Superimposed on Rated Load per Diode			I _{FSM}	150	A
Peak repetitive Reverse Current Per Leg at tp=2.0μs ,1KHz			I _{RRM}	1.0	A
Voltage Rate of Change (rated V _R)			Dv/dt	10000	V/μs
Operating Junction Temperature Range			T _J	- 55 to+150	°C
Storage Temperature Range			T _{STG}	- 55 to+150	°C
Maximum Instantaneous Forward Voltage per Leg	I _F =5A	T _C =25°C	V _F	0.92	V
		T _C =125°C		0.82	
Maximum Reverse Current per Leg at Working Peak Reverse Voltage		T _J =25°C	I _R	200	μA
		T _J =100°C		15	mA
Thermal Characteristics (T_A=25°C unless otherwise noted)					
Symbol	Parameter	Typ.(TO-263)			Unit
R _{θJC}	Thermal Resistance, Junction to Case per Leg	2.0			°C/W
R _{θJA}	Thermal Resistance, Junction to Ambient per Leg	62.5			°C/W

Note: Pulse test:300us pulse width, duty cycle=2%

Ratings and Characteristics Curves ($T_A = 25^\circ\text{C}$ unless otherwise noted)

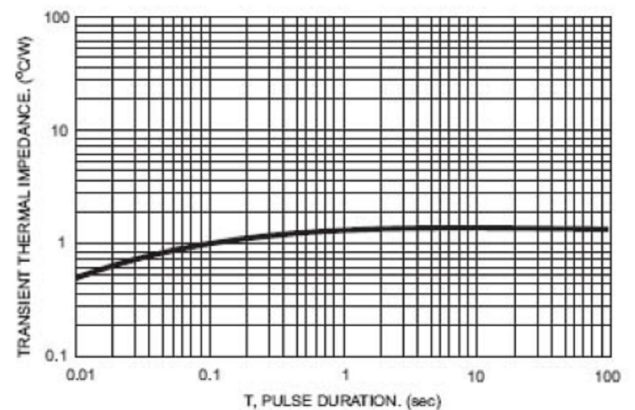
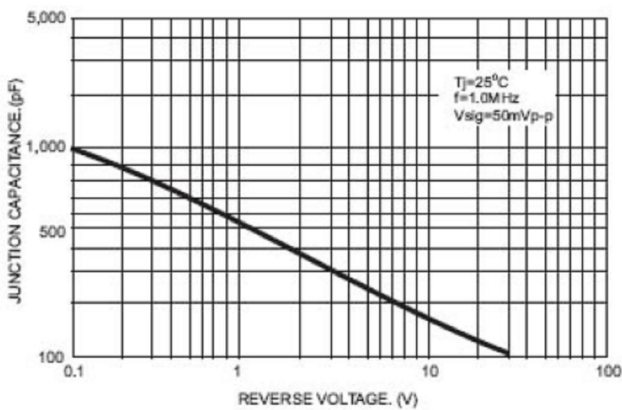
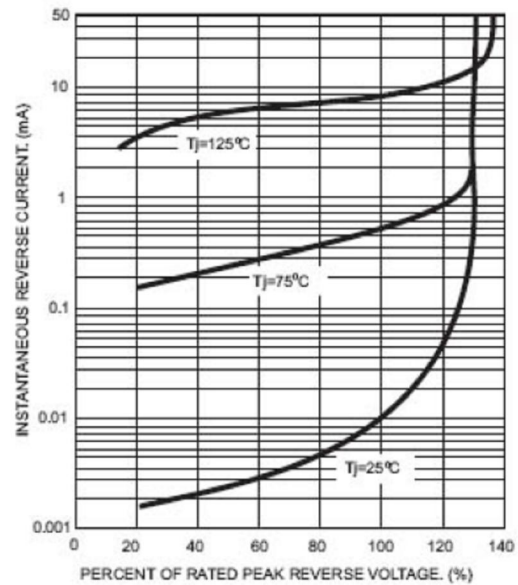
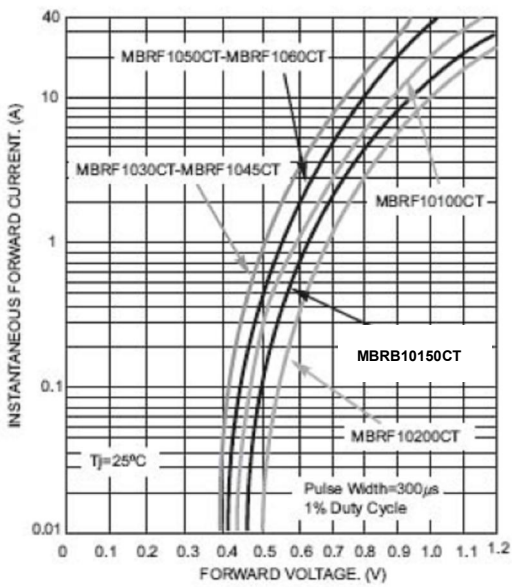
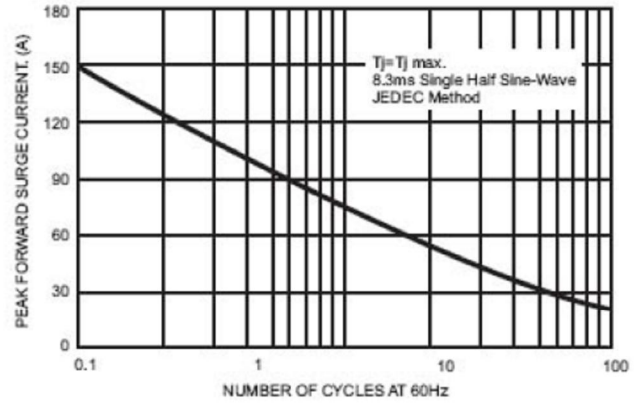
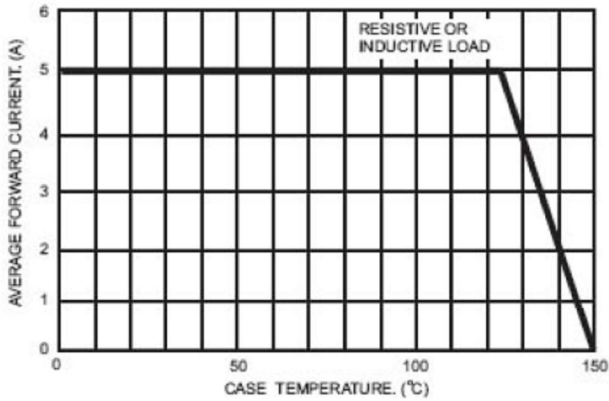

Package Outline Dimensions

in millimeters

TO-263

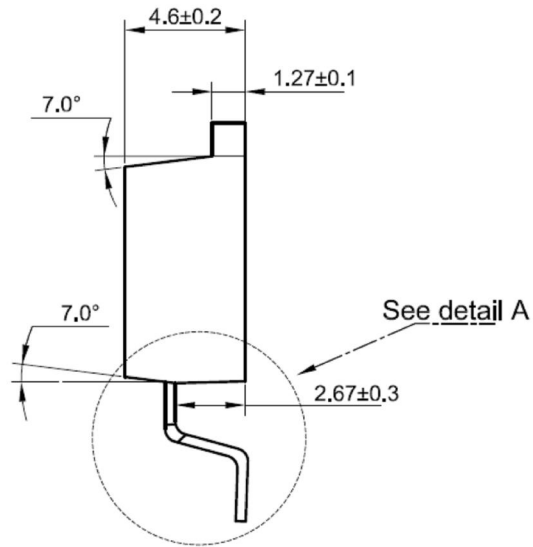
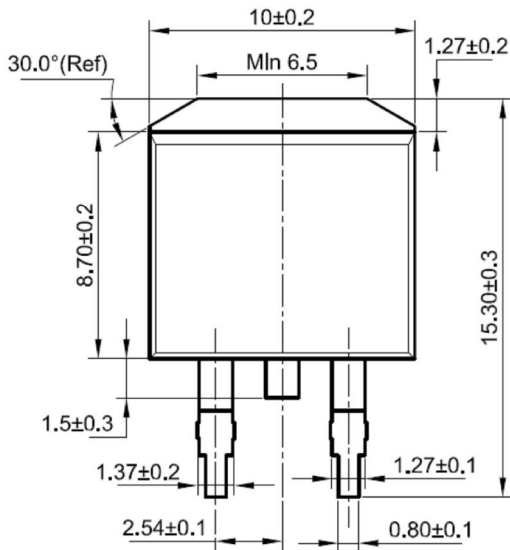

Detail A

