

MBR2060CT/MBRF2060CT

Schottky Barrier Rectifier
 Reverse Voltage 60 V Forward Current 20 A

Features

- Plastic package has underwriters Laboratory Flammability Classification 94V-0
- Dual rectifier construction, positive center tap
- Low forward voltage, high efficiency
- Guarding for over voltage protection



MBR2060CT
 Package: TO-220-AB

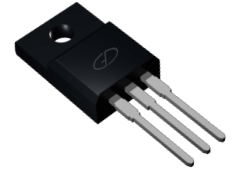

MBRF2060CT
 Package: ITO-220-AB

Mechanical Data

- Case: epoxy, molded
- Weight: 1.9grams (approximately)
- Finish: all external surfaces corrosion resistant and terminal leads readily solderable
- Lead temperature for soldering purpose: 260°C max. for 10 sec
- 50 units per plastic tube

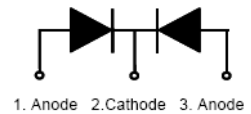

Schematic Diagram

Maximum Ratings & Electrical Characteristics

($T_A=25^\circ\text{C}$ unless otherwise noted)

Parameter	Test Conditions		Symbol	Value	Unit
Maximum Repetitive Peak Reverse Voltage			V_{RRM}	60	V
Working Peak Reverse Voltage			V_{RWM}	60	V
Maximum DC Blocking Voltage			V_{DC}	60	V
Maximum Average Forward Rectified Current @ $T_c=105^\circ\text{C}$	Total Device		$I_{F(AV)}$	20	A
	Per Diode			10	
Peak Forward Surge Current 8.3ms Single Half Sine-wave Superimposed on Rated Load per Diode			I_{FSM}	150	A
Peak repetitive Reverse Current Per Leg at $t_p=2.0\mu\text{s}$, 1KHz			I_{RRM}	1.0	A
Voltage Rate of Change (rated V_R)			DV/dt	10000	V/ μs
Operating Junction Temperature Range			T_J	- 55 to+150	$^\circ\text{C}$
Storage Temperature Range			T_{STG}	- 55 to+150	$^\circ\text{C}$
Isolation Voltage (ITO-220-AB only) from Terminal to Heatsink $t = 1 \text{ sec}$			V_{AC}	1500	V
Maximum Instantaneous Forward Voltage per Leg	$I_F=10\text{A}$	$T_c=25^\circ\text{C}$	V_F	0.80	V
	$I_F=10\text{A}$	$T_c=125^\circ\text{C}$		0.70	
Maximum Reverse Current per Leg at Working Peak Reverse Voltage		$T_J=25^\circ\text{C}$	I_R	200	μA
		$T_J=100^\circ\text{C}$		15	mA
Thermal Characteristics ($T_A=25^\circ\text{C}$ unless otherwise noted)					
Symbol	Parameter		Typ.(TO-220-AB)	Typ.(ITO-220-AB)	Unit
$R_{\theta JC}$	Thermal Resistance, Junction to Case per Leg		2.0	4.0	$^\circ\text{C/W}$
$R_{\theta JA}$	Thermal Resistance, Junction to Ambient per Leg		62.5	62.5	$^\circ\text{C/W}$

Note: Pulse test:300us pulse width, duty cycle=2%

Ratings and Characteristics Curves ($T_A = 25^\circ\text{C}$ unless otherwise noted)

FIG.1- FORWARD CURRENT DERATING CURVE

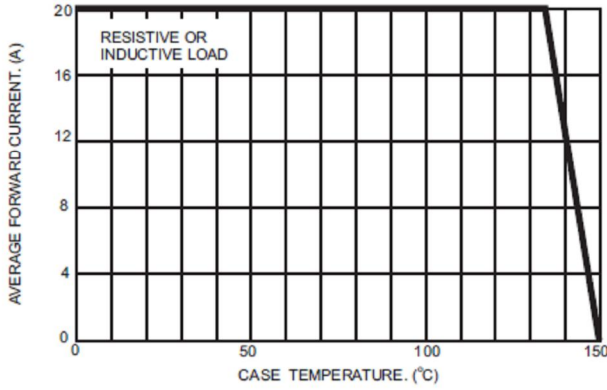

FIG.2- MAXIMUM NON-REPETITIVE FORWARD SURGE CURRENT PER LEG

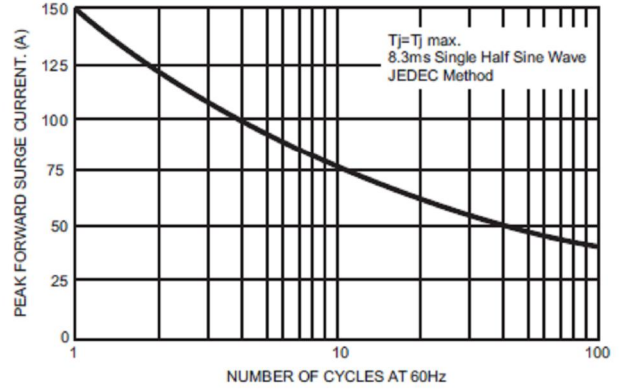

FIG.3- TYPICAL INSTANTANEOUS FORWARD CHARACTERISTICS PER LEG

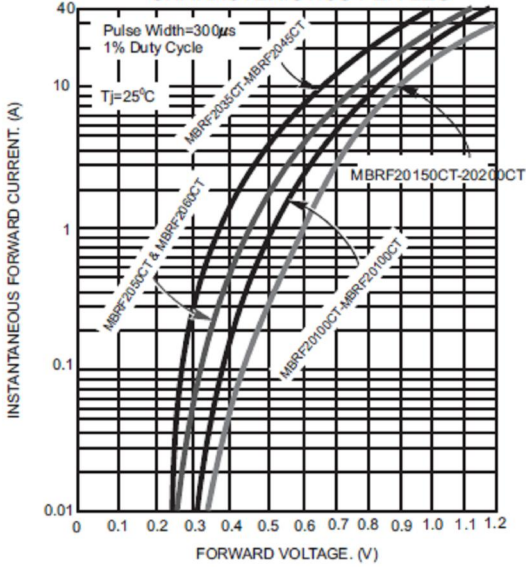

FIG.4- TYPICAL REVERSE CHARACTERISTICS PER LEG

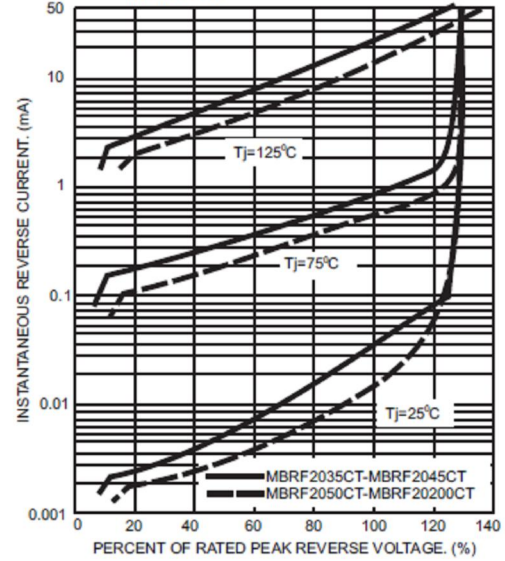

FIG.5- TYPICAL JUNCTION CAPACITANCE PER LEG

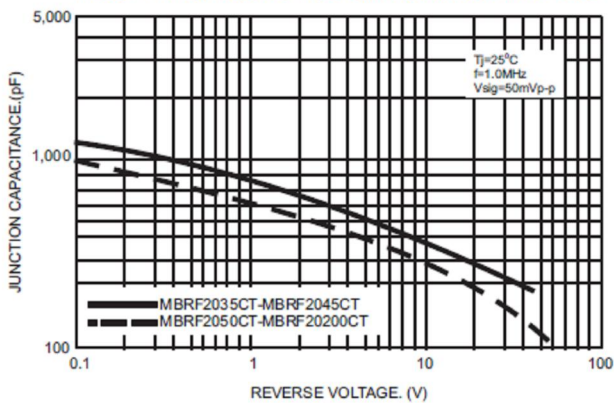
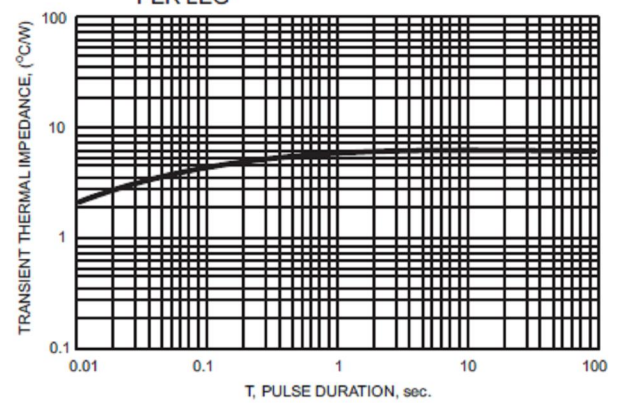

FIG.6- TYPICAL TRANSIENT THERMAL IMPEDANCE PER LEG



Package Outline Dimensions

in millimeters

TO-220-AB

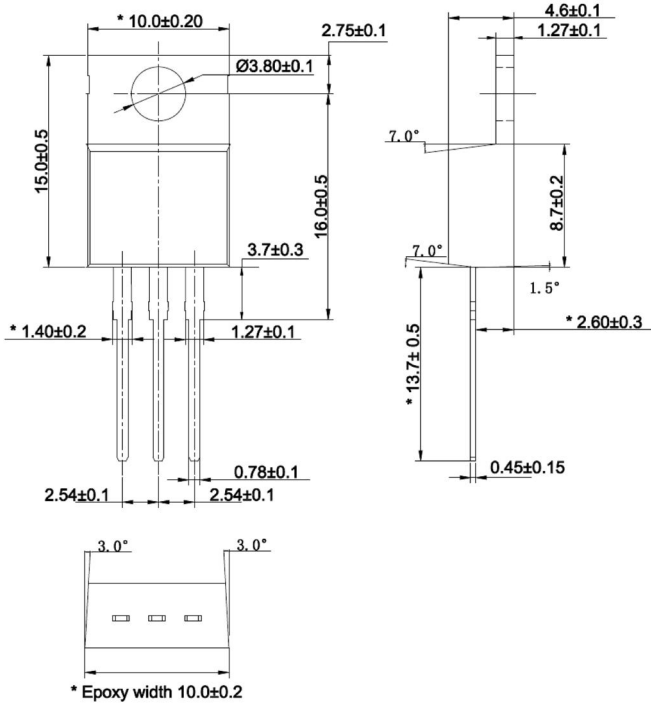

ITO-220-AB

