

Features

- Low profile - typical height 1.1 mm
- Low forward voltage drop
- Low leakage current
- Moisture sensitivity: level 1, per J-STD-020
- High temperature soldering guaranteed: 260°C/10 seconds
- Halogen-free according to IEC 61249-2-21 definition

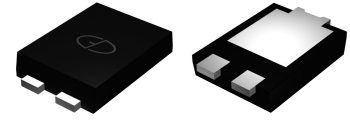

Package:
eSGC (TO-277)

Applications

For low voltage high frequency inverters, DC/DC converters and polarity protection applications.

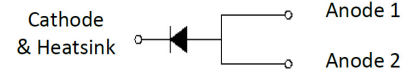

Schematic Diagram

Maximum Ratings (T_A = 25°C unless otherwise noted)

Parameter	Symbol	Value	Unit
Maximum Repetitive Peak Reverse Voltage	V _{RRM}	20	V
Maximum RMS Voltage	V _{RMS}	14	V
Maximum DC Blocking Voltage	V _{DC}	20	V
Maximum Average Forward Rectified Current	I _{F(AV)} ¹	10	A
	I _{F(AV)} ²	5	
Peak Forward Surge Current (8.3 ms single half sine-wave superimposed on rated load)	I _{FSM}	280	A
Operating Junction Temperature	T _J	-55 To +150	°C
Storage Temperature	T _{STG}	-55 To +150	°C

Electrical Characteristics (T_A = 25°C unless otherwise noted)

Parameter	Symbol	Conditions	Typ.	Max.	Unit		
Instantaneous Forward Voltage	V _F	I _F =1A	T _A =25°C	0.30	0.35	V	
		I _F =2A		0.33	0.38		
		I _F =8A		0.42	0.44		
		I _F =10A		0.44	0.45		
			I _F =1A	T _A =125°C	0.16		0.20
			I _F =2A		0.20		0.24
			I _F =8A		0.38		0.41
			I _F =10A		0.40		0.43
Instantaneous Reverse Current	I _R	V _R =35V	T _A =25°C	0.07	0.3	mA	
		V _R =40V		0.08	0.3		
		V _R =35V	T _A =100°C	4.5	35		
		V _R =40V		5	39		
Typical Junction Capacitance	C _J	4.0V, 1MHz	0.95		nF		
Typical Thermal Resistance ¹	R _{θJA}	Juntion to Ambient	80		°C/W		
	R _{θJC}	Juntion to Case	35				
	R _{θJM}	Juntion to Mount	20				

Note:1) The thermal resistance from junction to ambient,case or mount,mounted on P.C.B with 30×30mm copper pads,2 OZ,FR4 PCB

2) Mounted on recommended copper pad area, free air.

Ratings and Characteristics Curves ($T_A = 25^\circ\text{C}$ unless otherwise noted)

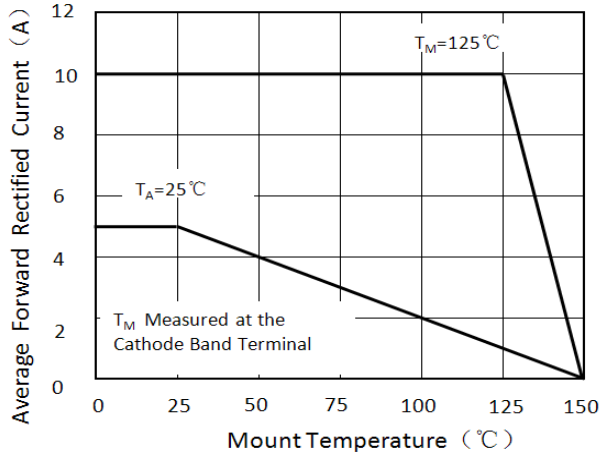

Figure 1. Forward Current Derating Curve

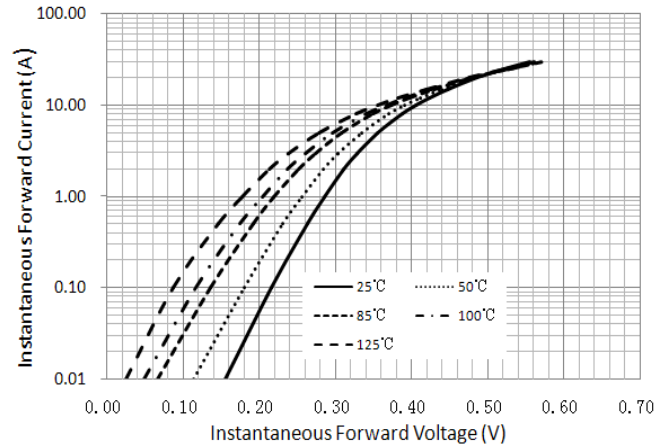

Figure 2. Typical Instantaneous Forward Characteristics

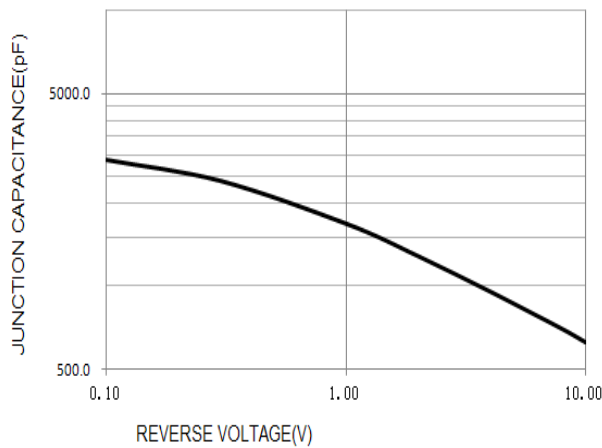

Figure 3. Typical Junction Capacitance

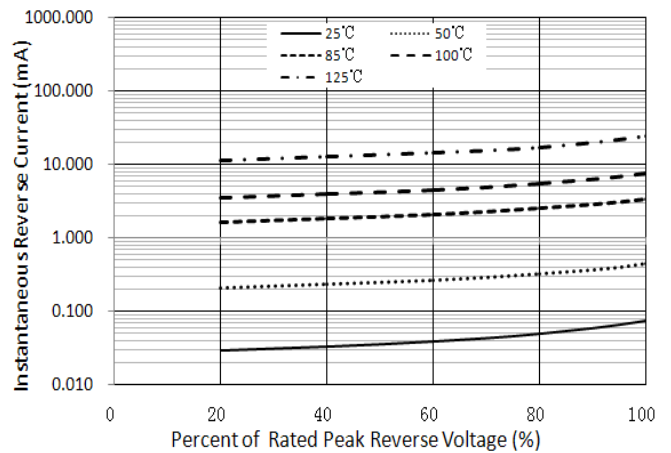

Figure 4. Typical Reverse Characteristics

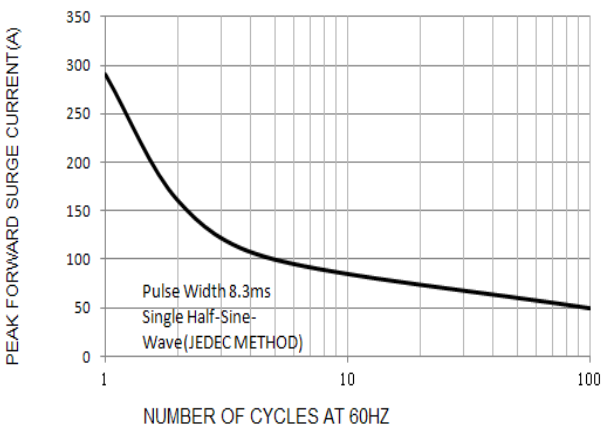
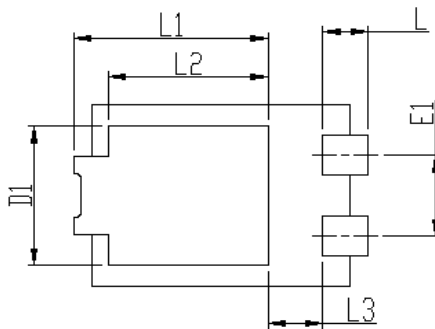
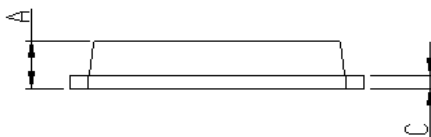
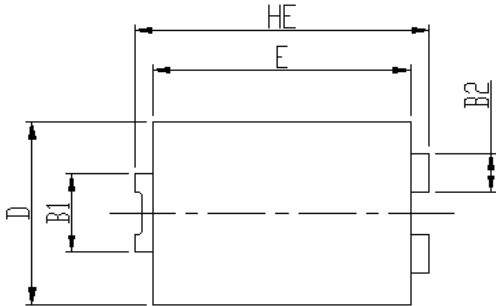

Figure 5. Maximum Non-Repetitive Peak Forward Surge Current

Package Outline Dimensions

eSGC (TO-277)



DIM	Unit: mm		Unit: inch	
	MIN	MAX	MIN	MAX
HE	6.4	6.6	0.252	0.260
E	5.6	5.8	0.220	0.228
D	4.1	4.3	0.161	0.169
B1	1.7	1.9	0.067	0.075
B2	0.8	1	0.031	0.039
A	1.05	1.2	0.041	0.047
C	0.3	0.4	0.012	0.016
L	0.85	1.1	0.033	0.043
L1	4.2	4.4	0.165	0.173
L2	3.52	Typ.	0.139	Typ.
L3	1.1	1.4	0.043	0.055
D1	3	3.3	0.118	0.130
E1	1.86	Typ.	0.073	Typ.

Soldering footprint

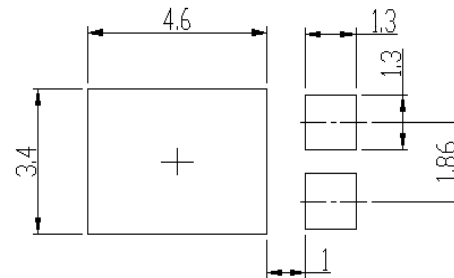

Packing Information

Packing quantities

5000 pcs/Reel, 12 mm Tape, 13" Reel

Tape & Reel Specification

