

Main Product Characteristics

$V_{(BR)DSS}$	-30V
$R_{DS(on)MAX}$	46mΩ@-10V
	72mΩ@-4.5V
I_D	-6.5A

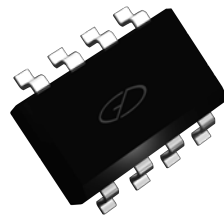

SOP-8



Marking and Pin Assignment

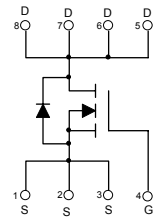

Schematic Diagram

Features and Benefits

- Advanced MOSFET process technology
- Ideal for battery operated systems, load switching, power converters and other general purpose applications
- Low on-resistance with low gate charge
- Fast switching and reverse body recovery



Description

The SSFQ4459 utilizes the latest techniques to achieve high cell density and low on-resistance. These features make this device extremely efficient and reliable for use in high efficiency switch mode power supply and a wide variety of other applications.

Absolute Maximum Ratings ($T_A=25^{\circ}C$ unless otherwise specified)

Parameter	Symbol	Value	Unit
Drain-Source Voltage	V_{DS}	-30	V
Gate-Source Voltage	V_{GS}	±20	V
Continuous Drain Current	I_D	-6.5	A
Pulsed Drain Current	I_{DM}	-26	A
Single Pulsed Avalanche Energy	$E_{AS}^{(1)}$	14	mJ
Power Dissipation	P_D	1.4	W
Thermal Resistance from Junction to Ambient	$R_{\theta JA}$	89	$^{\circ}C/W$
Junction Temperature	T_J	150	$^{\circ}C$
Storage Temperature Range	T_{STG}	-55 to +150	$^{\circ}C$
Lead Temperature for Soldering Purposes(1/8" from case for 10s)	T_L	260	$^{\circ}C$

(1). E_{AS} condition: $V_{DD}=-50V, L=0.1mH, R_G=25\Omega$, Starting $T_J = 25^{\circ}C$

Electrical Characteristics (T_A=25°C unless otherwise specified)

Parameter	Symbol	Test Condition	Min	Typ	Max	Unit
Off Characteristics						
Drain-Source Breakdown Voltage	V _{(BR)DSS}	V _{GS} = 0V, I _D = -250μA	-30	---	---	V
Zero Gate Voltage Drain Current	I _{DSS}	V _{DS} = -30V, V _{GS} = 0V	---	---	-1	μA
Gate-Body Leakage Current	I _{GSS}	V _{DS} = 0V, V _{GS} = ±20V	---	---	±100	nA
On Characteristics (note1)						
Gate-Threshold Voltage	V _{GS(th)}	V _{DS} = V _{GS} , I _D = -250μA	-1.4	-2.0	-2.4	V
Static Drain-Source On-State Resistance	R _{DS(on)}	V _{GS} = -10V, I _D = -6.5A	---	26	46	mΩ
		V _{GS} = -4.5V, I _D = -5A	---	46	72	mΩ
Forward Transconductance	g _{FS}	V _{DS} = -5V, I _D = -6.5A	6	---	---	S
Dynamic Characteristics						
Input Capacitance	C _{iss}	V _{DS} = -15V, V _{GS} = 0V, f = 1MHz	415	---	625	pF
Output Capacitance	C _{oss}		70	---	130	
Reverse Transfer Capacitance	C _{rss}		40	---	90	
Switching Characteristics						
Total Gate Charge	Q _g	V _{DS} = -15V, V _{GS} = -10V, I _D = -6.5A	7.4	---	11	nC
Gate-Source Charge	Q _{gs}		1.3	---	1.9	
Gate-Drain Charge	Q _{gd}		1.3	---	3.1	
Turn-On Delay Time	t _{d(on)}	V _{DD} = -15V, I _D = -1A, V _{GS} = -10V, R _G = 3Ω, R _L = 2.5Ω	---	7.5	---	ns
Turn-On Rise Time	t _r		---	5.5	---	
Turn-Off Delay Time	t _{d(off)}		---	19	---	
Turn-Off Fall Time	t _f		---	7	---	
Gate Resistance	R _g	f = 1MHz, V _{DS} = 0V, V _{GS} = 0V,	3.5	7.5	11.5	Ω
Drain-Source Diode Characteristics						
Drain-Source Diode Forward Voltage (note 1)	V _{SD}	V _{GS} = 0V, I _S = -1A	---	---	-1	V
Continuous Drain-Source Diode Forward Current	I _S		---	---	-6.5	A
Pulsed Drain-Source Diode Forward Current	I _{SM}		---	---	-26	A

Notes:

1. Pulse Test : Pulse Width ≤ 300μs, duty cycle ≤ 2%.

Typical Electrical and Thermal Characteristic Curves

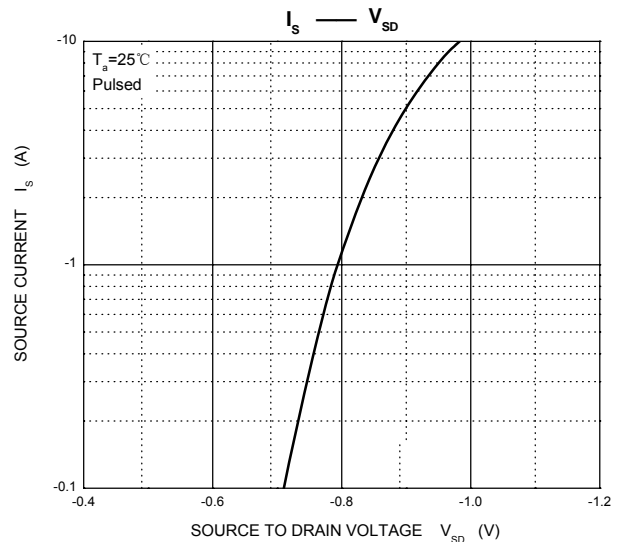
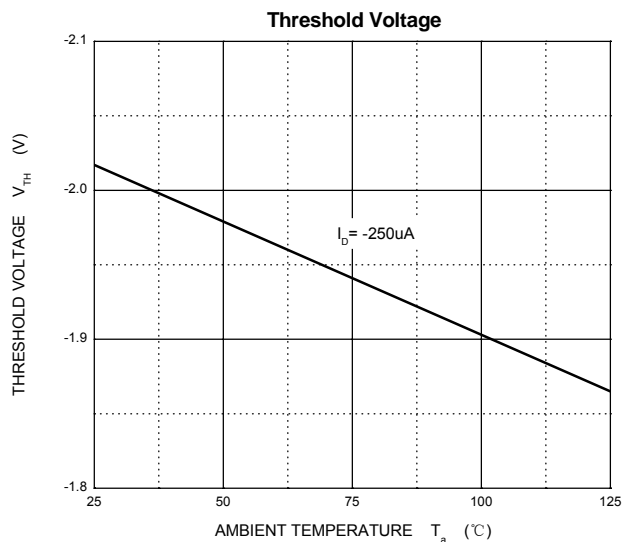
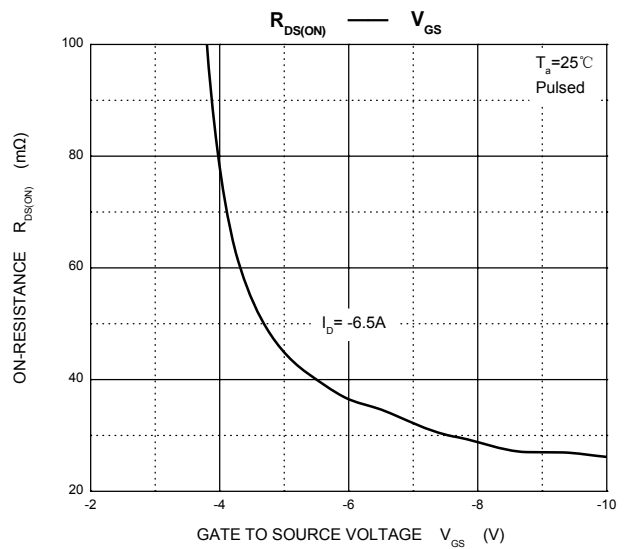
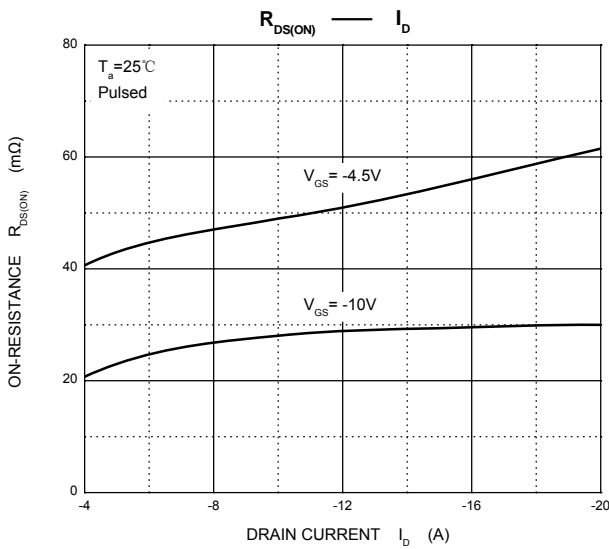
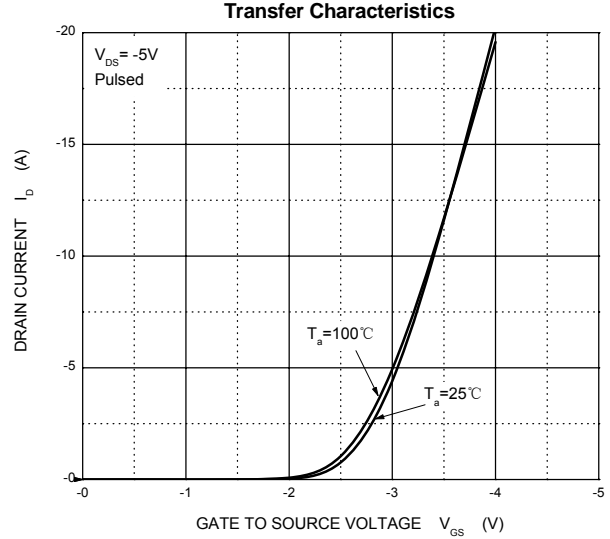
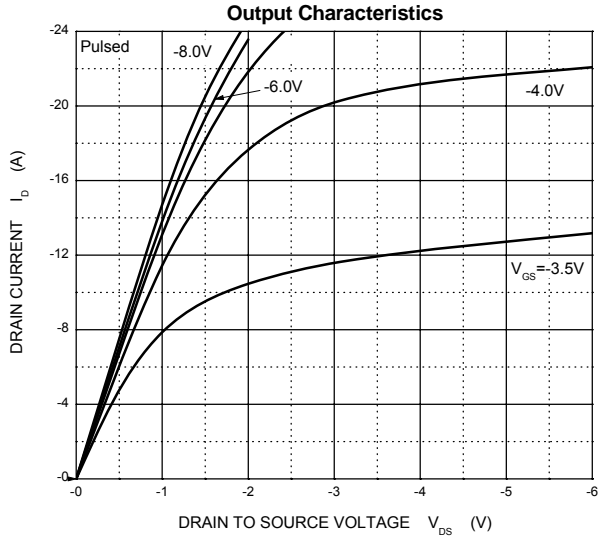

Package Outline Dimensions

SOP-8

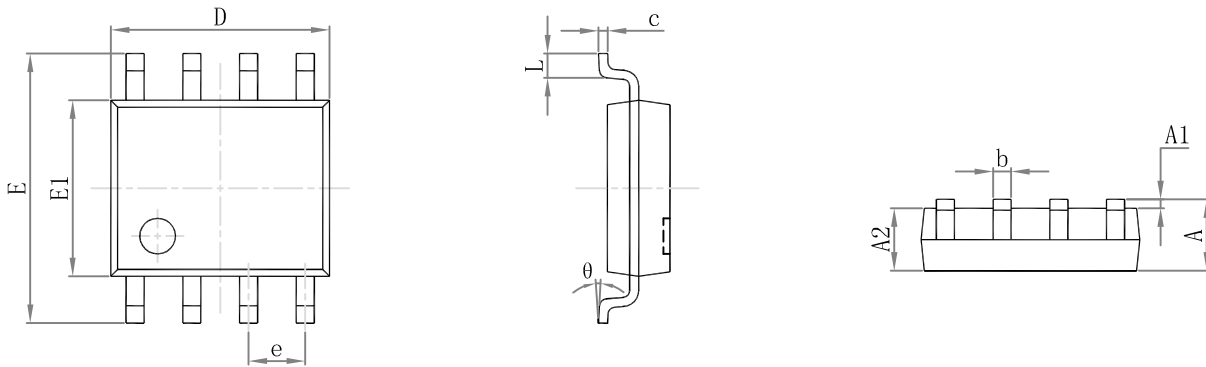

Symbol	Dimensions In Millimeters		Dimensions In Inches	
	Min	Max	Min	Max
A	1.350	1.750	0.053	0.069
A1	0.100	0.250	0.004	0.010
A2	1.350	1.550	0.053	0.061
b	0.330	0.510	0.013	0.020
c	0.170	0.250	0.007	0.010
D	4.800	5.000	0.189	0.197
e	1.270 (BSC)		0.050 (BSC)	
E	5.800	6.200	0.228	0.244
E1	3.800	4.000	0.150	0.157
L	0.400	1.270	0.016	0.050
θ	0°	8°	0°	8°

Suggested Pad Layout

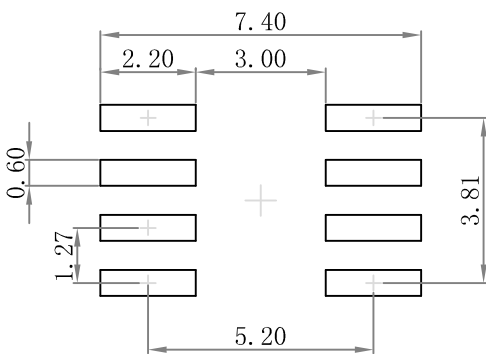

Note:
 1. Controlling dimension: in millimeters.
 2. General tolerance: $\pm 0.05\text{mm}$.
 3. The pad layout is for reference purposes only.