

Main Product Characteristics

$V_{(BR)DSS}$	40V
$R_{DS(ON)}$	2.8m Ω
I_D	100A

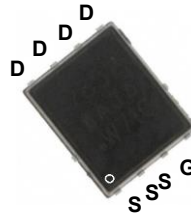

PPAK5X6

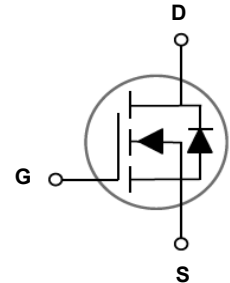

Schematic Diagram

Features and Benefits

- Advanced MOSFET process technology
- Ideal for high efficiency switched mode power supplies
- Low on-resistance with low gate charge
- Fast switching and reverse body recovery



Description

The SSFP4960 utilizes the latest techniques to achieve high cell density and low on-resistance. These features make this device extremely efficient and reliable for use in high efficiency switch mode power supply and a wide variety of other applications.

Absolute Maximum Ratings (T_C=25°C unless otherwise specified)

Parameter	Symbol	Rating	Unit
Drain-Source Voltage	V _{DS}	40	V
Gate-Source Voltage	V _{GS}	±20	V
Drain Current – Continuous (T _C =25°C)	I _D	100	A
Drain Current – Continuous (T _C =100°C)		63	A
Drain Current – Pulsed ¹	I _{DM}	400	A
Single Pulse Avalanche Energy ²	E _{AS}	312	mJ
Single Pulse Avalanche Current ²	I _{AS}	79	A
Power Dissipation (T _C =25°C)	P _D	135	W
Power Dissipation – Derate above 25°C		1.08	W/°C
Storage Temperature Range	T _{STG}	-55 to +150	°C
Operating Junction Temperature Range	T _J	-55 to +150	°C

Thermal Characteristics

Parameter	Symbol	Typ.	Max.	Unit
Thermal Resistance Junction to Ambient	R _{θJA}	---	62	°C/W
Thermal Resistance Junction to Case	R _{θJC}	---	0.92	°C/W

Electrical Characteristics ($T_J=25^\circ\text{C}$ unless otherwise specified)

Parameter	Symbol	Conditions	Min.	Typ.	Max.	Unit
Off Characteristics						
Drain-Source Breakdown Voltage	BV_{DSS}	$V_{GS}=0V, I_D=250\mu A$	40	---	---	V
BV_{DSS} Temperature Coefficient	$\Delta BV_{DSS}/\Delta T_J$	Reference to 25°C , $I_D=1\text{mA}$	---	0.03	---	$V/^\circ\text{C}$
Drain-Source Leakage Current	I_{DSS}	$V_{DS}=40V, V_{GS}=0V, T_J=25^\circ\text{C}$	---	---	1	μA
		$V_{DS}=32V, V_{GS}=0V, T_J=125^\circ\text{C}$	---	---	10	μA
Gate-Source Leakage Current	I_{GSS}	$V_{GS}=\pm 20V, V_{DS}=0V$	---	---	± 100	nA
On Characteristics						
Static Drain-Source On-Resistance ³	$R_{DS(ON)}$	$V_{GS}=10V, I_D=25A$	---	2.2	2.8	m Ω
		$V_{GS}=4.5V, I_D=12A$	---	2.6	3.5	m Ω
Gate Threshold Voltage	$V_{GS(th)}$	$V_{GS}=V_{DS}, I_D=250\mu A$	1.2	1.6	2.5	V
$V_{GS(th)}$ Temperature Coefficient	$\Delta V_{GS(th)}$		---	-5	---	mV/ $^\circ\text{C}$
Forward Transconductance	g_{fs}	$V_{DS}=10V, I_D=2A$	---	16	---	S
Dynamic Characteristics						
Total Gate Charge ^{3, 4}	Q_g	$V_{DS}=20V, V_{GS}=4.5V, I_D=10A$	---	44.4	80	nC
Gate-Source Charge ^{3, 4}	Q_{gs}		---	9.6	18	
Gate-Drain Charge ^{3, 4}	Q_{gd}		---	16	30	
Turn-On Delay Time ^{3, 4}	$T_{d(on)}$	$V_{DD}=20V, V_{GS}=10V, R_G=6\Omega, I_D=1A$	---	28	50	nS
Rise Time ^{3, 4}	T_r		---	3.2	6.5	
Turn-Off Delay Time ^{3, 4}	$T_{d(off)}$		---	89	160	
Fall Time ^{3, 4}	T_f		---	14	28	
Input Capacitance	C_{iss}	$V_{DS}=25V, V_{GS}=0V, F=1\text{MHz}$	---	4940	7800	pF
Output Capacitance	C_{oss}		---	425	800	
Reverse Transfer Capacitance	C_{rss}		---	170	330	
Gate Resistance	R_g	$V_{GS}=0V, V_{DS}=0V, F=1\text{MHz}$	---	1.4	2.8	Ω
Drain-Source Diode Characteristics						
Continuous Source Current	I_S	$V_G=V_D=0V, \text{Force Current}$	---	---	100	A
Pulsed Source Current ³	I_{SM}		---	---	200	A
Diode Forward Voltage ³	V_{SD}	$V_{GS}=0V, I_S=1A, T_J=25^\circ\text{C}$	---	---	1	V

Note:

1. Repetitive Rating: Pulsed width limited by maximum junction temperature.
2. $V_{DD}=25V, V_{GS}=10V, L=0.1\text{mH}, I_{AS}=79A, \text{Starting } T_J=25^\circ\text{C}$.
3. The data tested by pulsed, pulse width $\leq 300\mu\text{s}$, duty cycle $\leq 2\%$.
4. Essentially independent of operating temperature.

Typical Electrical and Thermal Characteristic Curves

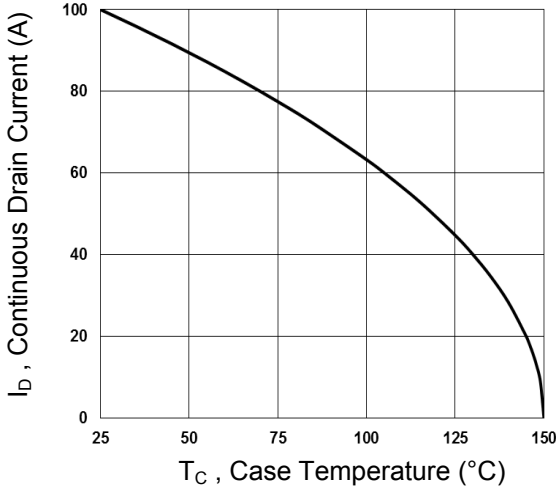

Fig.1 Continuous Drain Current vs. T_C

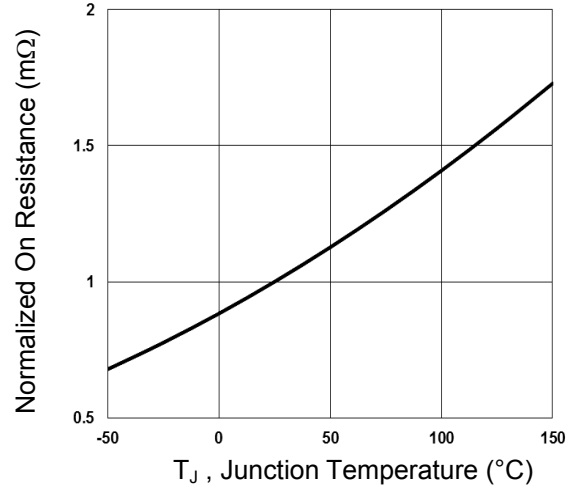

Fig.2 Normalized $R_{DS(ON)}$ vs. T_J

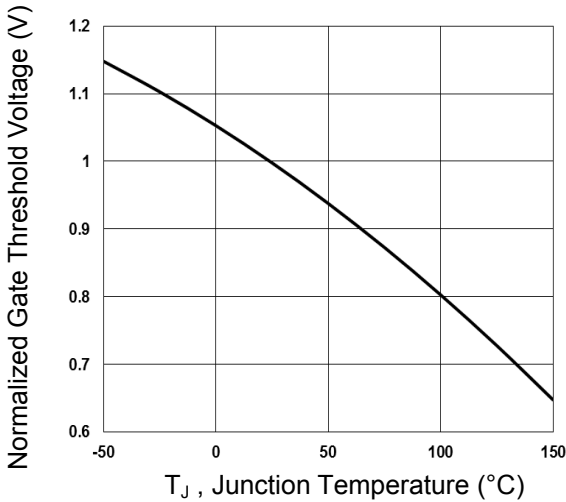

Fig.3 Normalized V_{th} vs. T_J

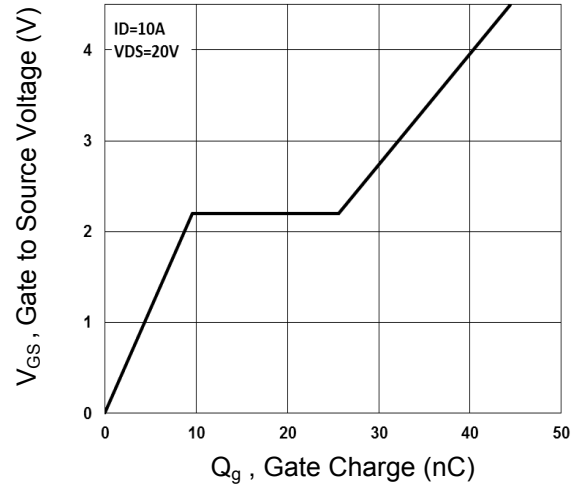

Fig.4 Gate Charge Waveform

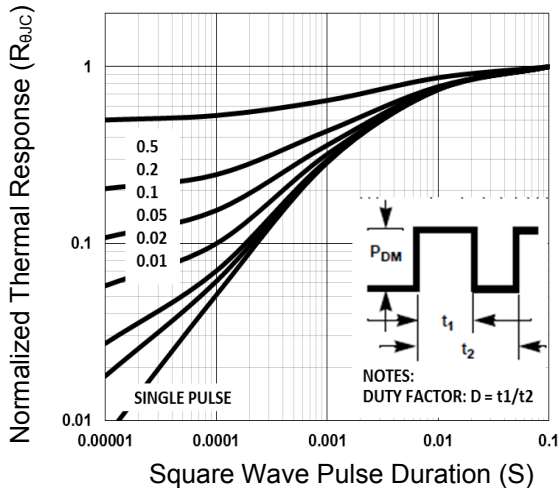

Fig.5 Normalized Transient Impedance

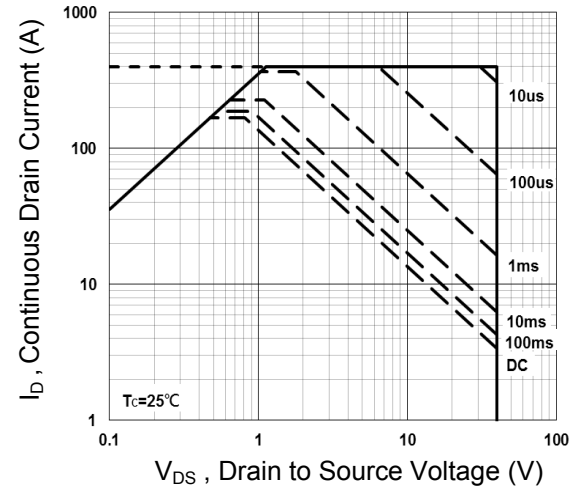

Fig.6 Maximum Safe Operation Area

Typical Electrical and Thermal Characteristic Curves

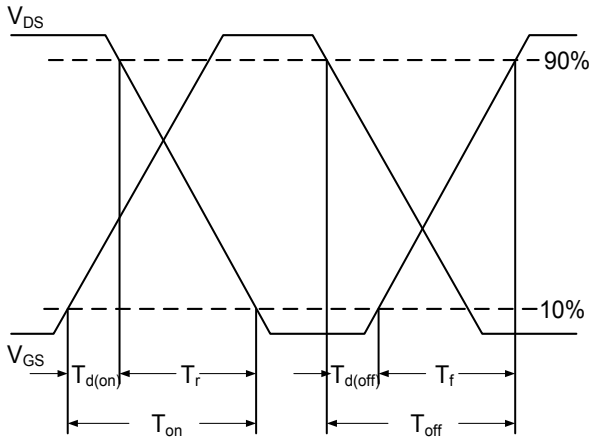

Fig.7 Switching Time Waveform

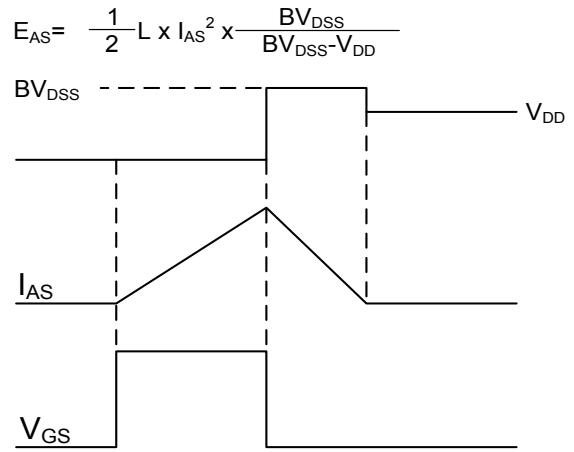
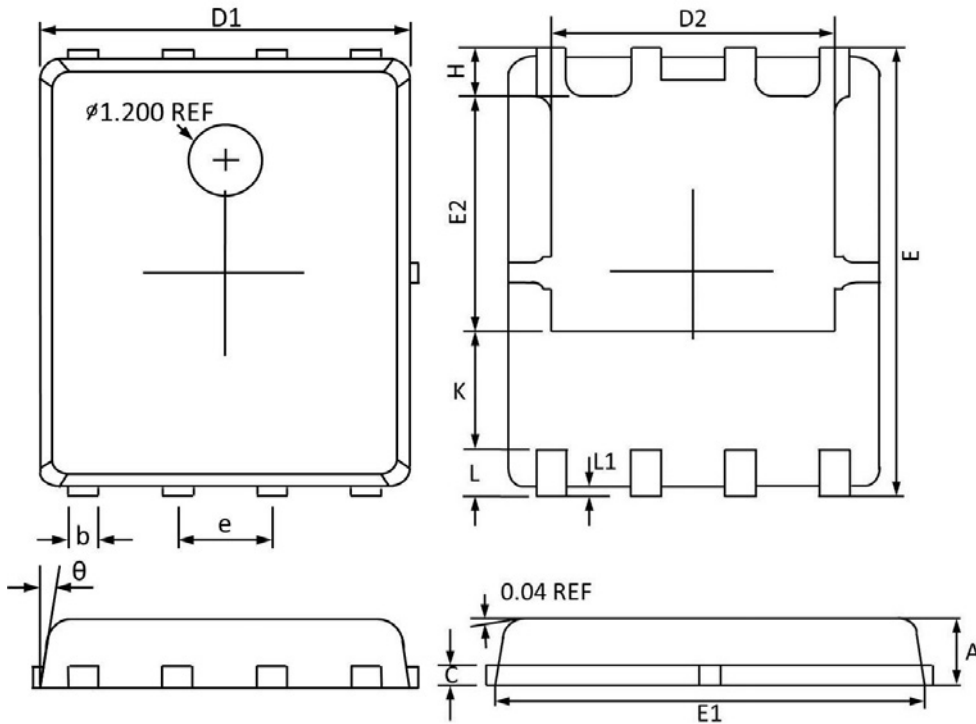

Fig. 8 E_{AS} Waveform

Package Outline Dimensions

PPAK5X6



Symbol	Dimensions In Millimeters		Dimensions In Inches	
	MAX	MIN	MAX	MIN
A	1.100	0.800	0.043	0.031
b	0.510	0.330	0.020	0.013
C	0.300	0.200	0.012	0.008
D1	5.100	4.800	0.201	0.189
D2	4.100	3.610	0.161	0.142
E	6.200	5.900	0.244	0.232
E1	5.900	5.700	0.232	0.224
E2	3.780	3.350	0.149	0.132
e	1.27BSC		0.05BSC	
H	0.700	0.410	0.028	0.016
K	1.500	1.100	0.059	0.043
L	0.710	0.510	0.028	0.020
L1	0.200	0.060	0.008	0.002