

Main Product Characteristics

BV_{DSS}	-30V
$R_{DS(ON)}$	20m Ω
I_D	-30A

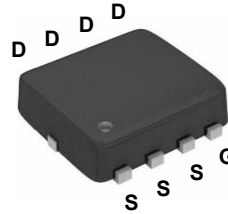

PPAK-3x3

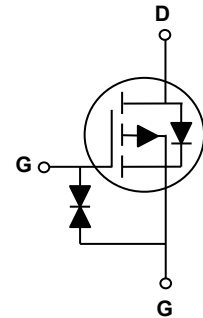

Schematic Diagram

Features and Benefits

- Advanced MOSFET process technology
- Ideal for high efficiency switched mode power supplies
- Low on-resistance with low gate charge
- Fast switching and reverse body recovery



Description

The SSFN7907 utilizes the latest techniques to achieve high cell density and low on-resistance. These features make this device extremely efficient and reliable for use in high efficiency switch mode power supply and a wide variety of other applications.

Absolute Maximum Ratings ($T_c=25^\circ\text{C}$ unless otherwise specified)

Parameter	Symbol	Rating	Unit
Drain-Source Voltage	V_{DS}	-30	V
Gate-Source Voltage	V_{GS}	± 20	V
Drain Current – Continuous ($T_c=25^\circ\text{C}$)	I_D	-30	A
Drain Current – Continuous ($T_c=100^\circ\text{C}$)		-19	A
Drain Current – Pulsed ¹	I_{DM}	-120	A
Power Dissipation ($T_c=25^\circ\text{C}$)	P_D	27	W
Power Dissipation – Derate above 25°C		0.22	W/ $^\circ\text{C}$
Storage Temperature Range	T_{STG}	-55 to +150	$^\circ\text{C}$
Operating Junction Temperature Range	T_J	-55 to +150	$^\circ\text{C}$

Thermal Characteristics

Parameter	Symbol	Typ.	Max.	Unit
Thermal Resistance Junction to Ambient	$R_{\theta JA}$	---	62	$^\circ\text{C/W}$
Thermal Resistance Junction to Case	$R_{\theta JC}$	---	4.6	$^\circ\text{C/W}$

Electrical Characteristics ($T_J=25^\circ\text{C}$ unless otherwise specified)

Parameter	Symbol	Conditions	Min.	Typ.	Max.	Unit
Off Characteristics						
Drain-Source Breakdown Voltage	BV_{DSS}	$V_{GS}=0V, I_D=250\mu A$	-30	---	---	V
BV_{DSS} Temperature Coefficient	$\Delta BV_{DSS}/\Delta T_J$	Reference to 25°C , $I_D=-1\text{mA}$	---	-0.03	---	$V/^\circ\text{C}$
Drain-Source Leakage Current	I_{DSS}	$V_{DS}=-27V, V_{GS}=0V, T_J=25^\circ\text{C}$	---	---	-1	μA
		$V_{DS}=-24V, V_{GS}=0V, T_J=125^\circ\text{C}$	---	---	-10	μA
Gate-Source Leakage Current	I_{GSS}	$V_{GS}=\pm 20V, V_{DS}=0V$	---	---	± 20	nA
On Characteristics						
Static Drain-Source On-Resistance	$R_{DS(ON)}$	$V_{GS}=-10V, I_D=-8A$	---	16	20	m Ω
		$V_{GS}=-4.5V, I_D=-6A$	---	26	35	
Gate Threshold Voltage	$V_{GS(th)}$	$V_{GS}=V_{DS}, I_D=-250\mu A$	-1.2	-1.6	-2.5	V
$V_{GS(th)}$ Temperature Coefficient	$\Delta V_{GS(th)}$		---	4	---	$\text{mV}/^\circ\text{C}$
Forward Transconductance	g_{fs}	$V_{DS}=-10V, I_D=-8A$	---	6.8	---	S
Dynamic and Switching Characteristics						
Total Gate Charge ^{2,3}	Q_g	$V_{DS}=-15V, V_{GS}=-4.5V, I_D=-5A$	---	11	17	nC
Gate-Source Charge ^{2,3}	Q_{gs}		---	3.4	6	
Gate-Drain Charge ^{2,3}	Q_{gd}		---	4.2	8	
Turn-On Delay Time ^{2,3}	$T_{d(on)}$	$V_{DD}=-15V, V_{GS}=-10V, R_G=6\Omega, I_D=-1A$	---	5.8	11	nS
Rise Time ^{2,3}	T_r		---	18.8	36	
Turn-Off Delay Time ^{2,3}	$T_{d(off)}$		---	46.9	90	
Fall Time ^{2,3}	T_f		---	12.3	23	
Input Capacitance	C_{iss}	$V_{DS}=-15V, V_{GS}=0V, F=1\text{MHz}$	---	1250	2500	μF
Output Capacitance	C_{oss}		---	160	320	
Reverse Transfer Capacitance	C_{rss}		---	90	180	
Drain-Source Diode Characteristics and Maximum Ratings						
Parameter	Symbol	Conditions	Min.	Typ.	Max.	Unit
Continuous Source Current	I_S	$V_G=V_D=0V, \text{Force Current}$	---	---	-30	A
Pulsed Source Current	I_{SM}		---	---	-60	A
Diode Forward Voltage	V_{SD}	$V_{GS}=0V, I_S=-1A, T_J=25^\circ\text{C}$	---	---	-1	V

Note:

1. Repetitive Rating: Pulsed width limited by maximum junction temperature.
2. The data tested by pulsed, pulse width $\leq 300\mu\text{s}$, duty cycle $\leq 2\%$.
3. Essentially independent of operating temperature.

Typical Electrical and Thermal Characteristic Curves

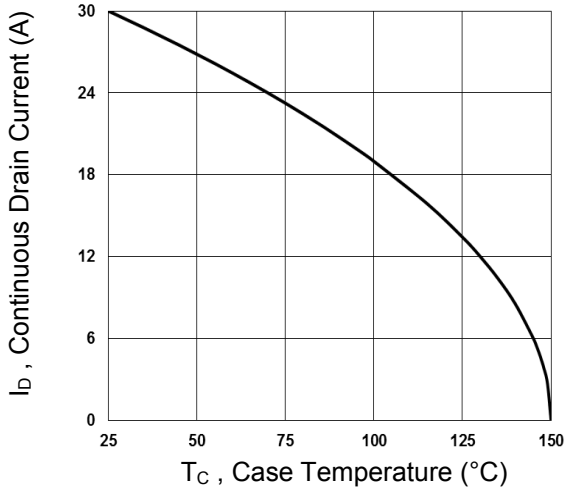

Fig.1 Continuous Drain Current vs. T_c

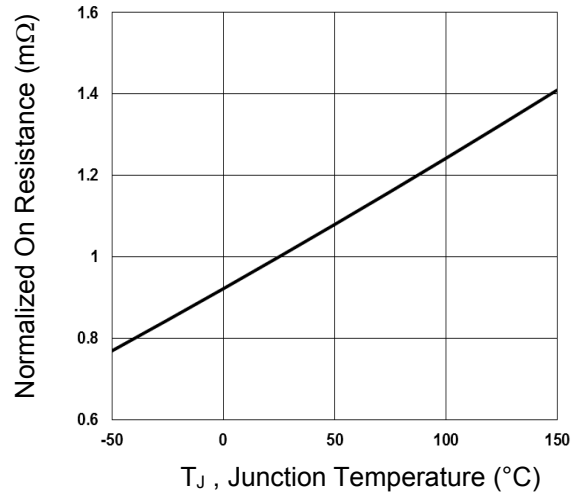

Fig.2 Normalized R_{DS(ON)} vs. T_j

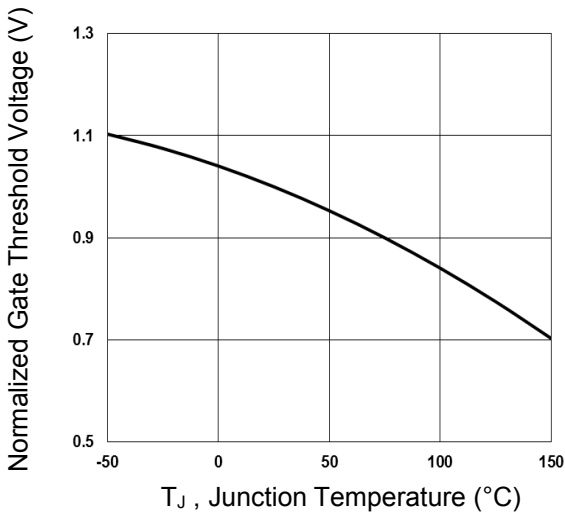

Fig.3 Normalized V_{th} vs. T_j

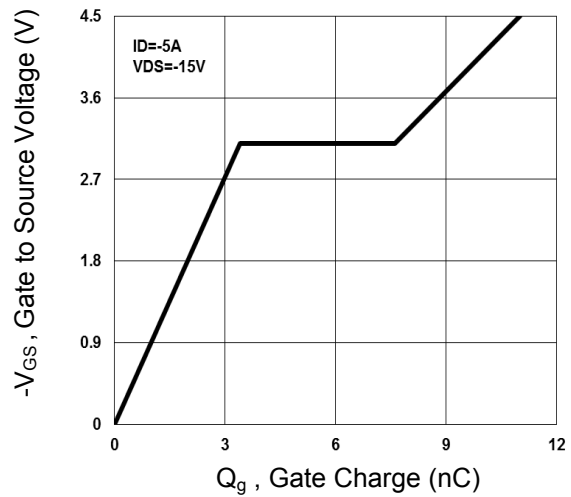

Fig.4 Gate Charge Waveform

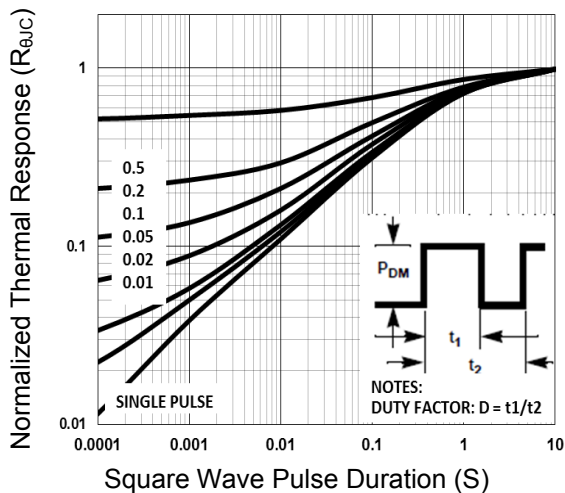

Fig.5 Normalized Transient Impedance

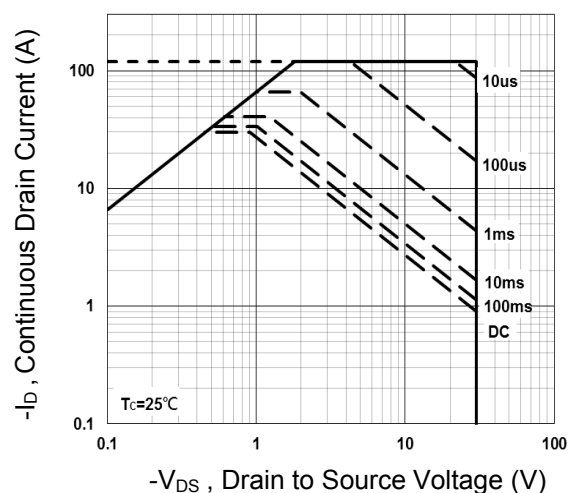

Fig.6 Maximum Safe Operation Area

Typical Electrical and Thermal Characteristic Curves

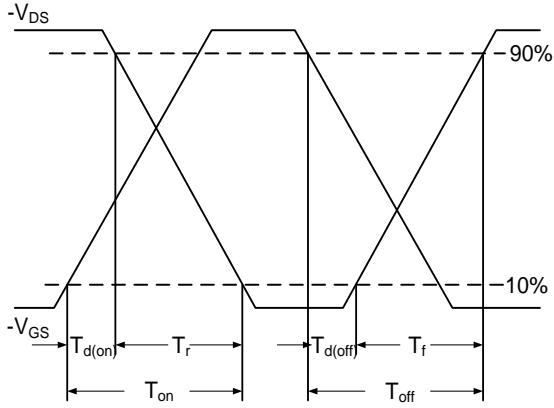

Fig.7 Switching Time Waveform

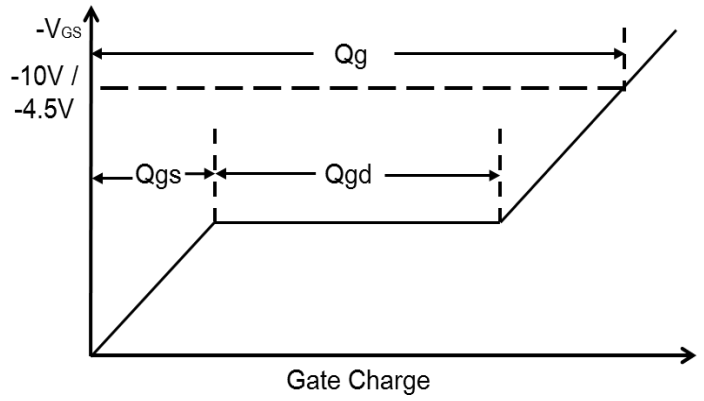
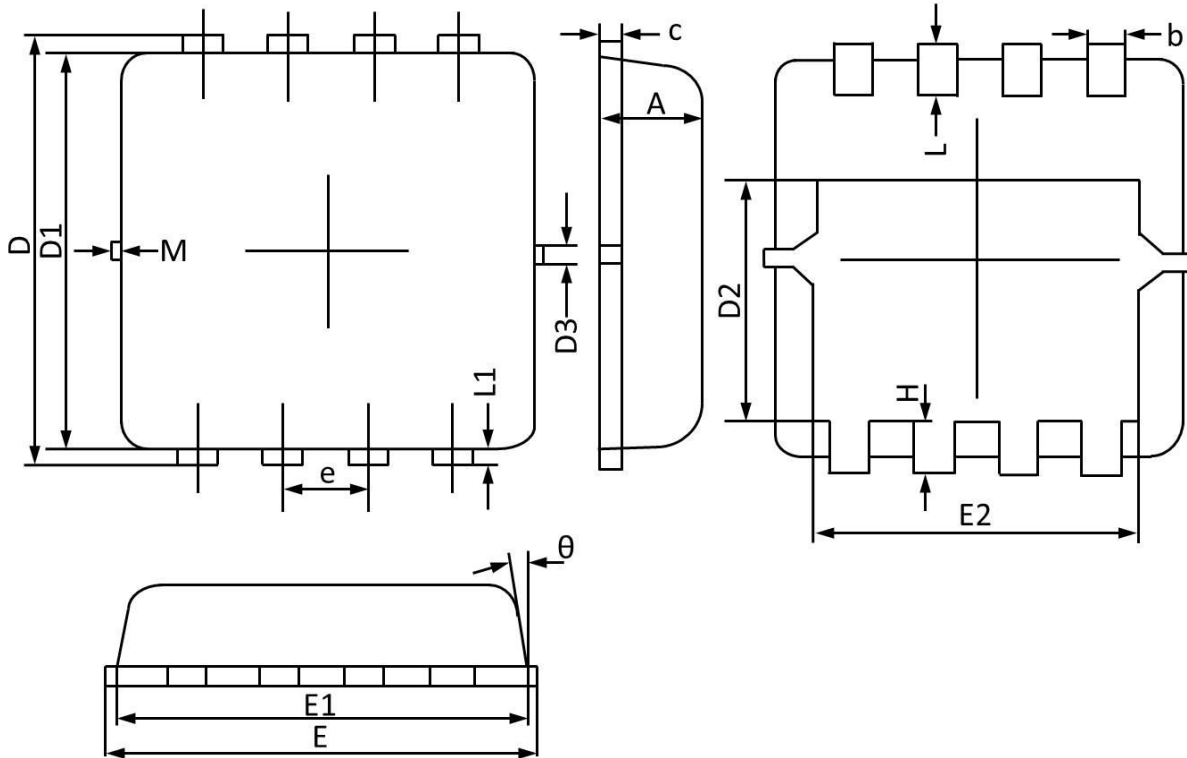

Fig.8 Gate Charge Waveform

Package Outline Dimensions

PPAK3x3



Symbol	Dimensions In Millimeters		Dimensions In Inches	
	MAX	MIN	MAX	MIN
A	0.900	0.700	0.035	0.028
b	0.350	0.240	0.014	0.009
c	0.250	0.100	0.010	0.004
D	3.450	3.050	0.136	0.120
D1	3.200	2.900	0.126	0.114
D2	1.850	1.350	0.073	0.053
E	3.400	3.000	0.134	0.118
E1	3.250	2.900	0.128	0.114
E2	2.600	2.350	0.102	0.093
e	0.65BSC		0.026BSC	
H	0.500	0.300	0.020	0.012
L	0.500	0.300	0.020	0.012
L1	0.200	0.070	0.008	0.003
θ	12°	0°	12°	0°