

Main Product Characteristics

V_{DSS}	-20V
$R_{DS(ON)}$	640mΩ
I_D	-0.85A

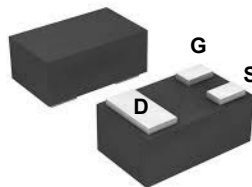

SOT-883

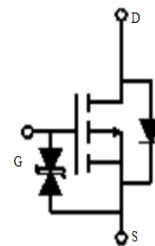

Schematic Diagram

Features and Benefits

- Advanced MOSFET process technology
- Ideal for high efficiency switched mode power supplies
- Low on-resistance with low gate charge
- Fast switching and reverse body recovery



Description

The GSFW02009 utilizes the latest techniques to achieve high cell density and low on-resistance. These features make this device extremely efficient and reliable for use in high efficiency switch mode power supply and a wide variety of other applications.

Absolute Maximum Ratings ($T_J=25^{\circ}C$ unless otherwise specified)

Parameter	Symbol	Max.	Unit
Drain-Source Voltage	V_{DSS}	-20	V
Gate-Source Voltage	V_{GSS}	±12	V
Drain Current-Continuous($T_A=25^{\circ}C$) ^{1,3}	I_D	-0.85	A
Drain Current-Continuous($T_A=70^{\circ}C$) ^{1,3}		-0.68	
Pulse Drain Current ²	I_{DM}	-2.1	A
Power Dissipation($T_A=25^{\circ}C$)	P_D	0.69	W
Power Dissipation($T_A=70^{\circ}C$)		0.44	
Thermal Resistance, Junction-to-Ambient ²	$R_{\theta JA}$	180	°C/W
Storage Temperature Range	T_{STG}	-55 To +150	°C
Operating Junction Temperature Range	T_J	-55 To +150	°C

Electrical Characteristics ($T_J=25^{\circ}\text{C}$ unless otherwise specified)

Parameter	Symbol	Conditions	Min.	Typ.	Max.	Unit
Drain-Source Breakdown Voltage	$V_{(BR)DSS}$	$V_{GS}=0V, I_D=-250\mu A$	-20	-	-	V
Zero Gate Voltage Drain Current	I_{DSS}	$V_{DS}=-16V, V_{GS}=0V$	-	-	-1	μA
Gate Threshold Voltage	$V_{GS(th)}$	$V_{DS}=V_{GS}, I_{DSS}=-250\mu A$	-0.5	-	-1	V
Gate-Source Leakage Current	I_{GSS}	$V_{GS}=\pm 12V, V_{DS}=0V$	-	-	± 10	μA
Drain-Source On-State Resistance	$R_{DS(on)}$	$V_{GS}=-4.5V, I_D=-0.55A$	-	530	640	m Ω
		$V_{GS}=-2.5V, I_D=-0.45A$	-	730	950	
		$V_{GS}=-1.8V, I_D=-0.35A$	-	1300	1950	
Forward Transconductance	g_{fs}	$V_{GS}=-5V, I_D=-0.55A$	-	1	-	S
Total Gate Charge	Q_g	$V_{DS}=-10V, I_D=-1A, V_{GS}=-2.5V$	-	0.53	-	nC
Total Gate Charge	Q_g	$V_{DS}=-10V, I_D=-1A, V_{GS}=-4.5V$	-	0.8	-	nC
Gate-Source Charge	Q_{gs}		-	0.2	-	
Gate-Drain Charge	Q_{gd}		-	0.2	-	
Turn-On Delay Time	$t_{d(on)}$	$V_{DS}=-10V, R_{GEN}=3\Omega, V_{GS}=-4.5V, I_D=-1.33A$	-	400	-	nS
Turn-On Rise Time	t_r		-	60	-	
Turn-Off Delay Time	$t_{d(off)}$		-	20	-	
Turn-Off Fall Time	t_f		-	800	-	
Input Capacitance	C_{iss}	$V_{DS}=-10V, V_{GS}=0V, F=1MHz$	-	58	-	pF
Output Capacitance	C_{oss}		-	5.7	-	
Reverse Transfer Capacitance	C_{rss}		-	4.4	-	
Reverse Diode Characteristics						
Diode Forward Voltage	V_{SD}	$V_{GS}=0V, I_{SD}=-1A$	-	-	-1.1	V
Reverse Recovery Time	t_{rr}	$I_F=-1A, di/dt=100A/\mu s$	-	9.2	-	nS
Reverse Recovery Charge	Q_{rr}		-	0.8	-	nC

Note :

1. The value of $R_{\theta JA}$ is measured with the device mounted on 1in2 FR-4 board with 2oz. Copper, in a still air environment with $T_A=25^{\circ}\text{C}$. The value in any given application depends on the user's specific board design.
2. Repetitive rating, pulse width limited by junction temperature .
3. The current rating is based on the $t < 10s$ junction to ambient thermal resistance rating.

Typical Electrical and Thermal Characteristic Curves

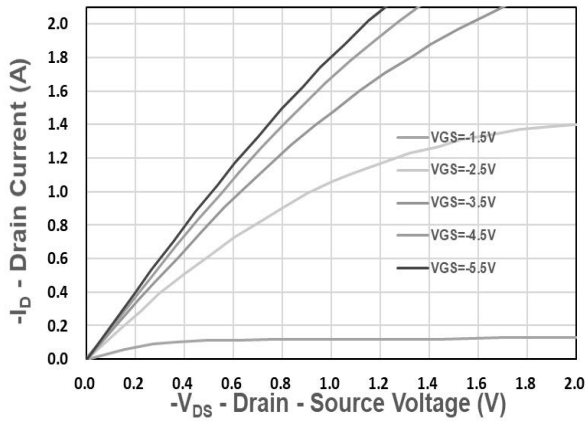

Figure 1. Output Characteristics

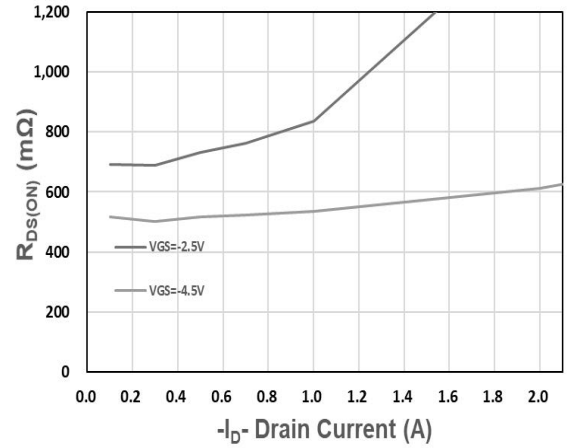

Figure 2. On-Resistance vs. I_D

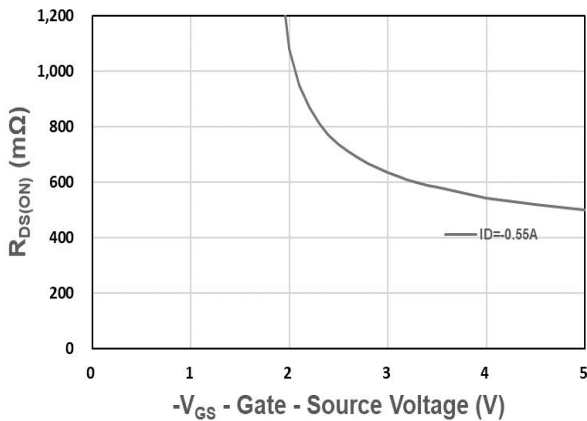

Figure 3. On-Resistance vs. V_{GS}

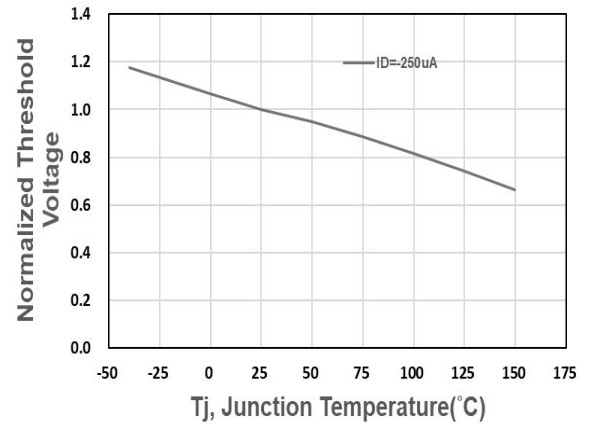

Figure 4. Gate Threshold Voltage

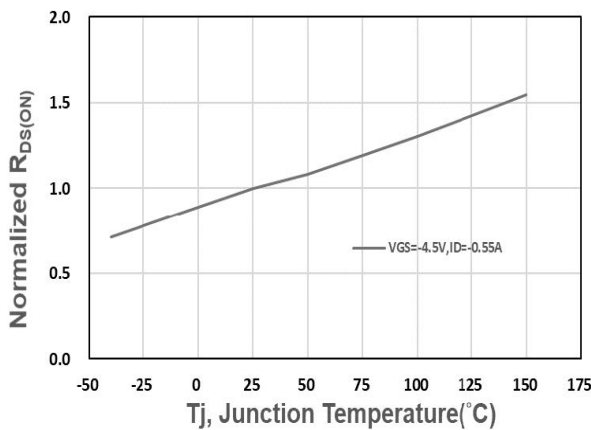

Figure 5. Drain-Source On Resistance

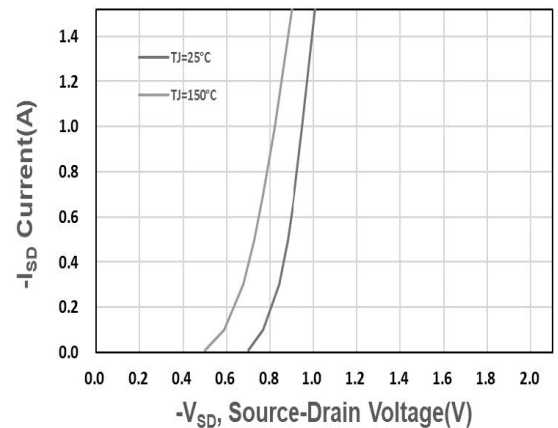

Figure 6. Source-Drain Diode Forward

Typical Electrical and Thermal Characteristic Curves

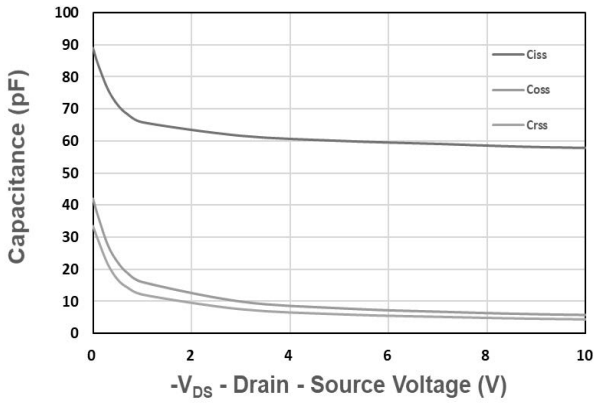

Figure 7. Capacitance

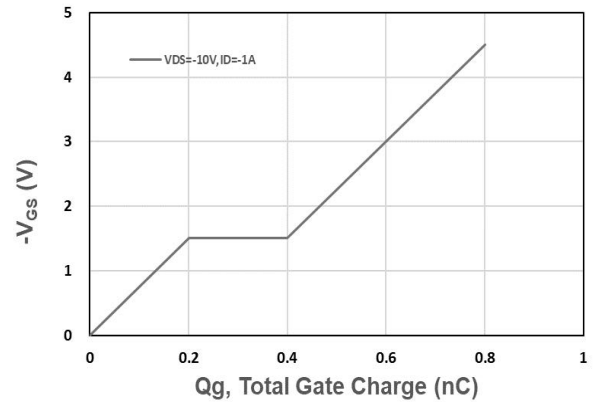

Figure 8. Gate Charge Characteristics

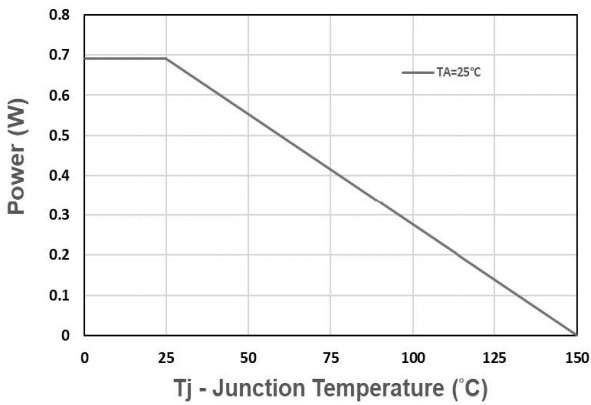

Figure 9. Power Dissipation

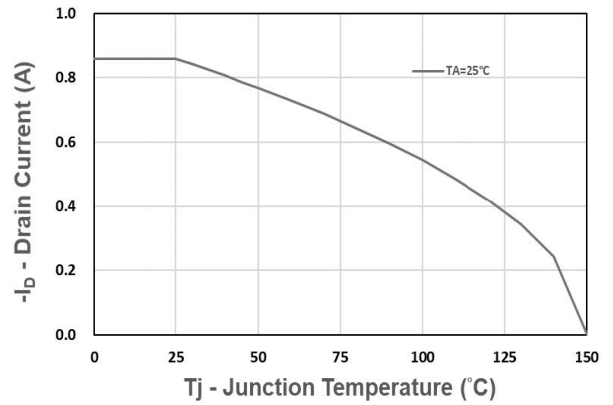

Figure 10. Drain Current

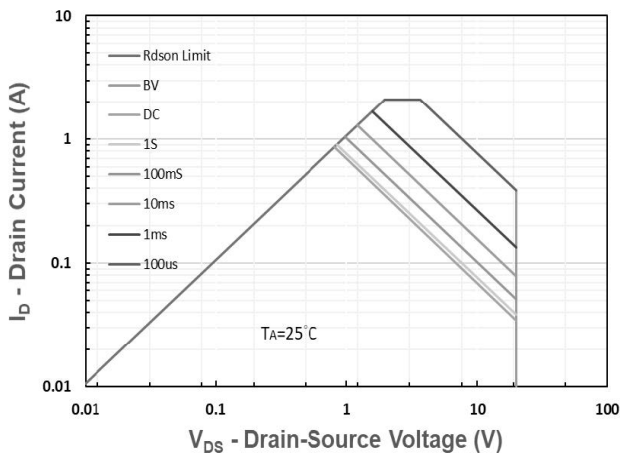

Figure 11. Safe Operating Area

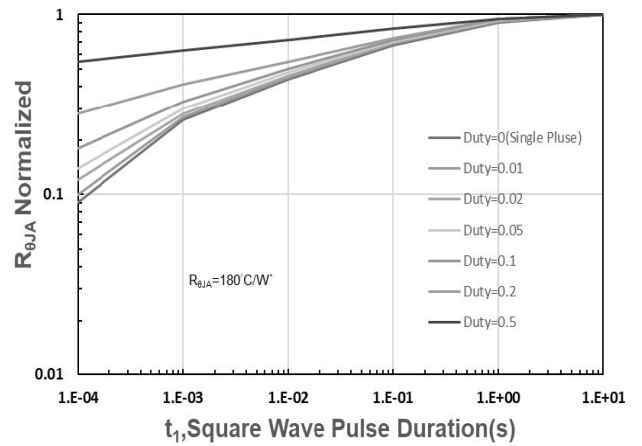
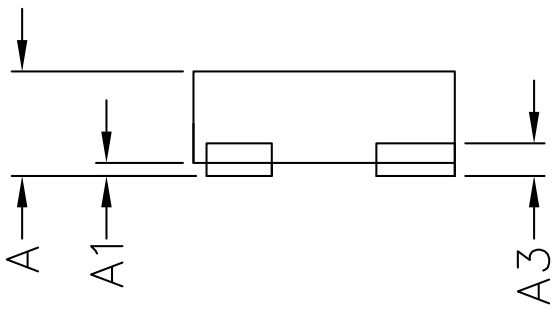
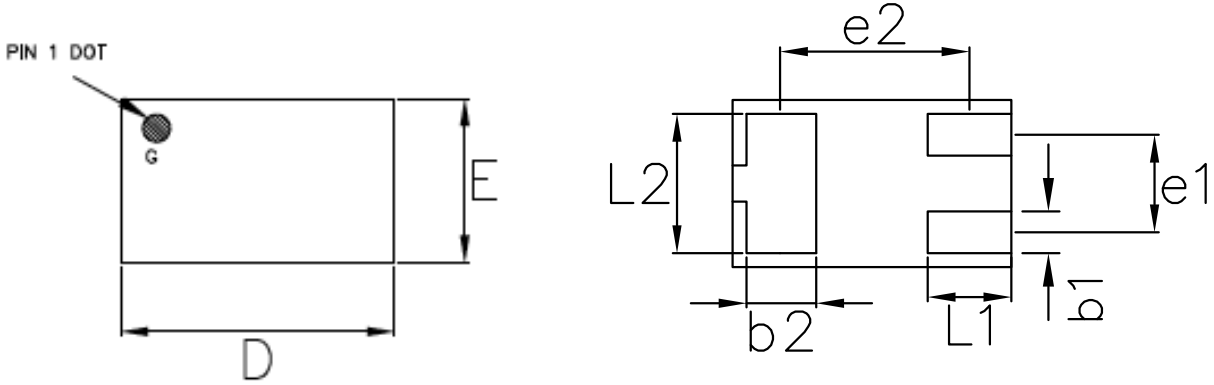

Figure 12. $R_{\theta JA}$ Transient Thermal Impedance

Package Outline Dimensions (SOT-883)



Package Outline Dimensions (MM)			
Package	SOT-883		
REF.	MIN.	TYP.	MAX
A	0.40	-	0.50
A1	0.001	-	0.05
A3	0.125 REF.		
D	0.95	1.00	1.05
E	0.55	0.60	0.65
b1	0.10	0.15	0.20
b2	0.20	0.25	0.30
L1	0.20	0.30	0.40
L2	0.40	0.50	0.60
e1	0.35 BSC		
e2	0.675 BSC		

Recommended Pad Layout

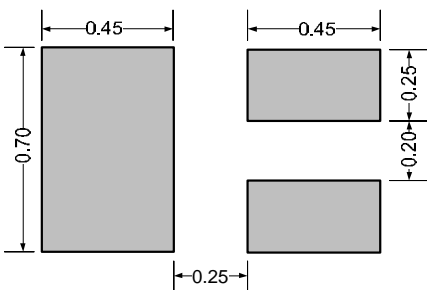

(Unit in MM)

Order Information

MPN	Package	Marking Code	Carrier	Quantity	HSF Status
GSFW02009	SOT-883	4A	Tape & Reel	10000/Reel	RoHS Compliant