

Main Product Characteristics

$V_{(BR)DSS}$	-60V
$R_{DS(ON)}$	30mΩ
I_D	-8.5A

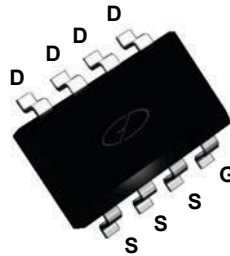

SOP-8

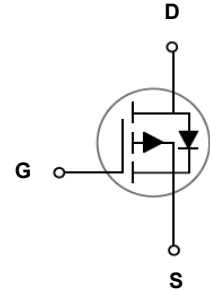

Schematic Diagram

Features and Benefits

- Advanced MOSFET process technology
- Ideal for high efficiency switched mode power supplies
- Low on-resistance with low gate charge
- Fast switching and reverse body recovery



Description

The GSFQ6903 utilizes the latest techniques to achieve high cell density and low on-resistance. These features make this device extremely efficient and reliable for use in high efficiency switch mode power supply and a wide variety of other applications.

Absolute Maximum Ratings ($T_c=25^{\circ}C$ unless otherwise specified)

Parameter	Symbol	Rating	Unit
Drain-Source Voltage	V_{DS}	-60	V
Gate-Source Voltage	V_{GS}	±20	V
Drain Current – Continuous ($T_c=25^{\circ}C$)	I_D	-8.5	A
Drain Current – Continuous ($T_c=100^{\circ}C$)		-5.4	A
Drain Current – Pulsed ¹	I_{DM}	-34	A
Power Dissipation ($T_c=25^{\circ}C$)	P_D	4.1	W
Power Dissipation – Derate above 25°C		0.033	W/°C
Storage Temperature Range	T_{STG}	-55 to +150	°C
Operating Junction Temperature Range	T_J	-55 to +150	°C

Thermal Characteristics

Parameter	Symbol	Typ.	Max.	Unit
Thermal Resistance Junction to Case	$R_{\theta JC}$	---	30	°C/W
Thermal Resistance Junction to Ambient	$R_{\theta JA}$	---	62	°C/W

Electrical Characteristics ($T_J=25^\circ\text{C}$ unless otherwise specified)

Parameter	Symbol	Conditions	Min.	Typ.	Max.	Unit
Off Characteristics						
Drain-Source Breakdown Voltage	BV_{DSS}	$V_{GS}=0V, I_D=-250\mu A$	-60	---	---	V
Drain-Source Leakage Current	I_{DSS}	$V_{DS}=-60V, V_{GS}=0V, T_J=25^\circ\text{C}$	---	---	-1	μA
		$V_{DS}=-48V, V_{GS}=0V, T_J=125^\circ\text{C}$	---	---	-10	μA
Gate-Source Leakage Current	I_{GSS}	$V_{GS}=\pm 20V, V_{DS}=0V$	---	---	± 100	nA
On Characteristics						
Static Drain-Source On-Resistance	$R_{DS(ON)}$	$V_{GS}=-10V, I_D=-8A$	---	23	30	m Ω
		$V_{GS}=-4.5V, I_D=-6A$	---	28	40	m Ω
Gate Threshold Voltage	$V_{GS(th)}$	$V_{GS}=V_{DS}, I_D=-250\mu A$	-1	-1.6	-2.5	V
Forward Transconductance	g_{fs}	$V_{DS}=-10V, I_D=-3A$	---	18	---	S
Dynamic and Switching Characteristics						
Total Gate Charge ^{2, 3}	Q_g	$V_{DS}=-30V, V_{GS}=-10V, I_D=-5A$	---	43.8	88	nC
Gate-Source Charge ^{2, 3}	Q_{gs}		---	4.6	9	
Gate-Drain Charge ^{2, 3}	Q_{gd}		---	8.3	17	
Turn-On Delay Time ^{2, 3}	$T_{d(on)}$	$V_{DD}=-30V, V_{GS}=-10V, R_G=6\Omega, I_D=-1A$	---	25	50	nS
Rise Time ^{2, 3}	T_r		---	13.8	28	
Turn-Off Delay Time ^{2, 3}	$T_{d(off)}$		---	148	290	
Fall Time ^{2, 3}	T_f		---	51	100	
Input Capacitance	C_{iss}	$V_{DS}=-25V, V_{GS}=0V, F=1\text{MHz}$	---	2595	3900	pF
Output Capacitance	C_{oss}		---	162	240	
Reverse Transfer Capacitance	C_{rss}		---	115	170	
Drain-Source Diode Characteristics and Maximum Ratings						
Continuous Source Current	I_S	$V_G=V_D=0V, \text{Force Current}$	---	---	-8.5	A
Pulsed Source Current	I_{SM}		---	---	-17	A
Diode Forward Voltage	V_{SD}	$V_{GS}=0V, I_S=-1A, T_J=25^\circ\text{C}$	---	---	-1	V

Note:

1. Repetitive Rating: Pulsed width limited by maximum junction temperature.
2. The data tested by pulsed, pulse width $\leq 300\mu\text{s}$, duty cycle $\leq 2\%$.
3. Essentially independent of operating temperature.

Typical Electrical and Thermal Characteristic Curves

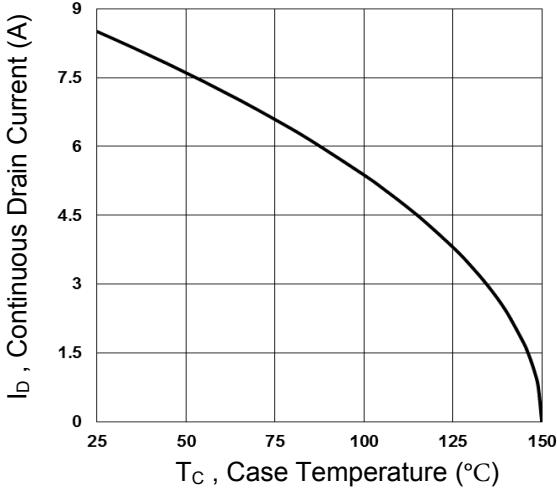

Fig.1 Continuous Drain Current vs. T_C

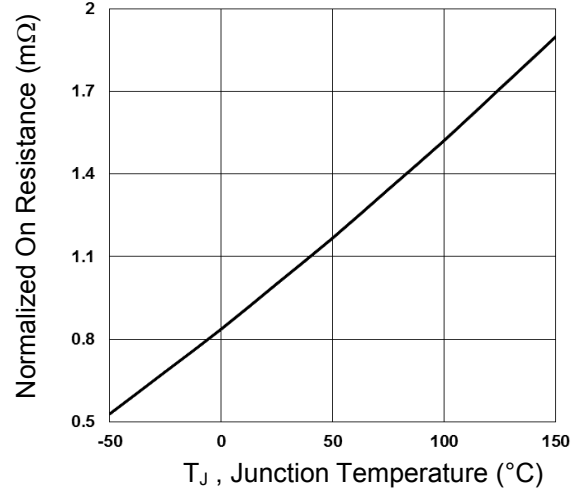

Fig.2 Normalized $R_{DS(ON)}$ vs. T_J

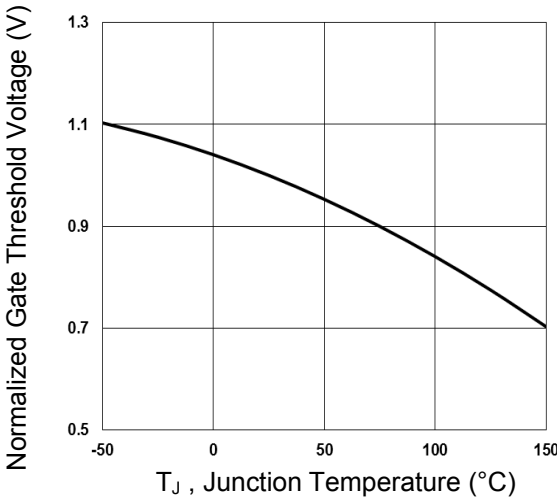

Fig.3 Normalized V_{th} vs. T_J

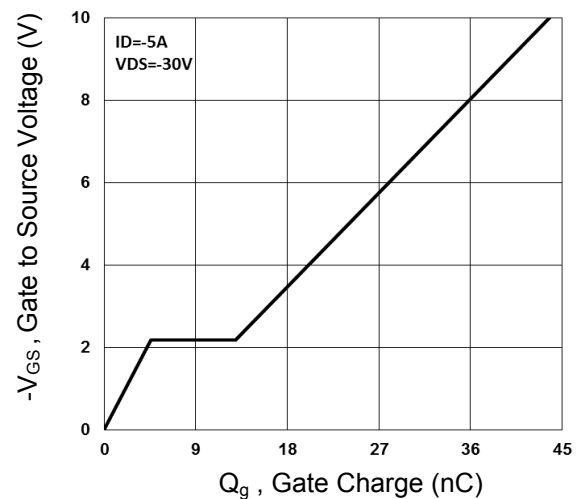

Fig.4 Gate Charge Waveform

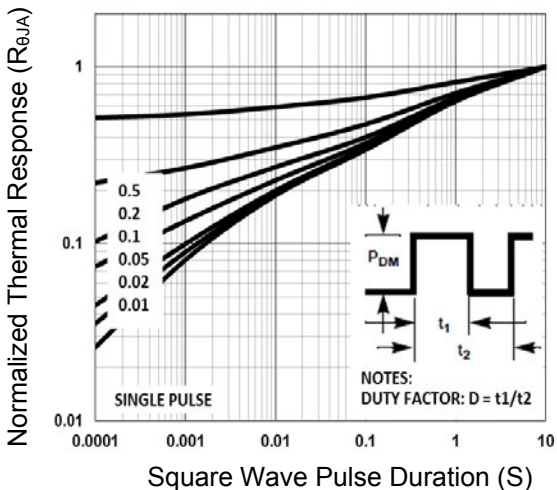

Fig.5 Normalized Transient Impedance

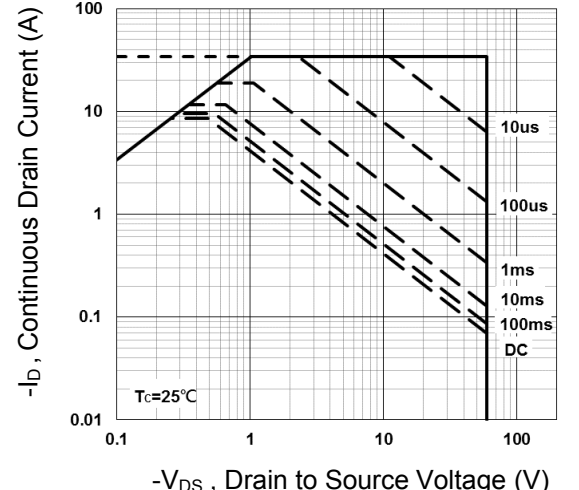

Fig.6 Maximum Safe Operation Area

Typical Electrical and Thermal Characteristic Curves

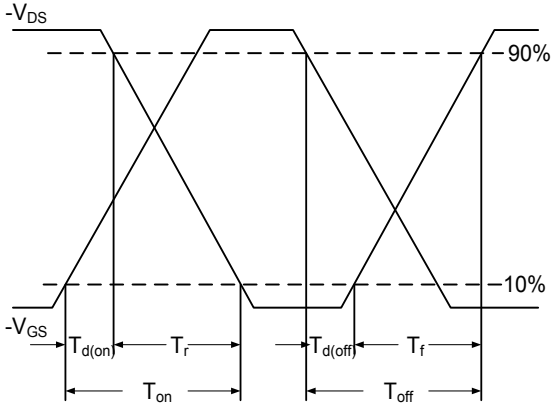

Fig.7 Switching Time Waveform

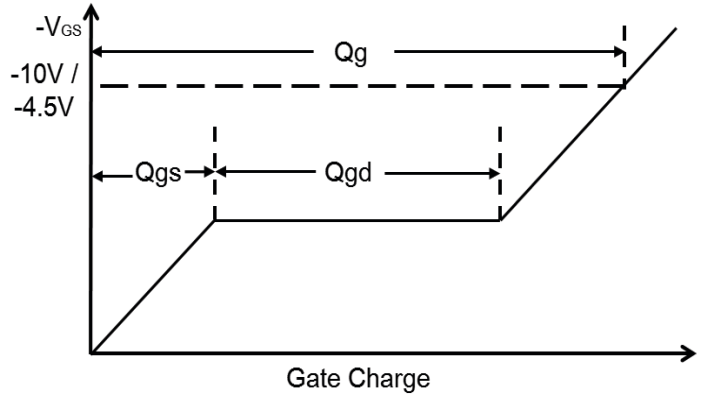
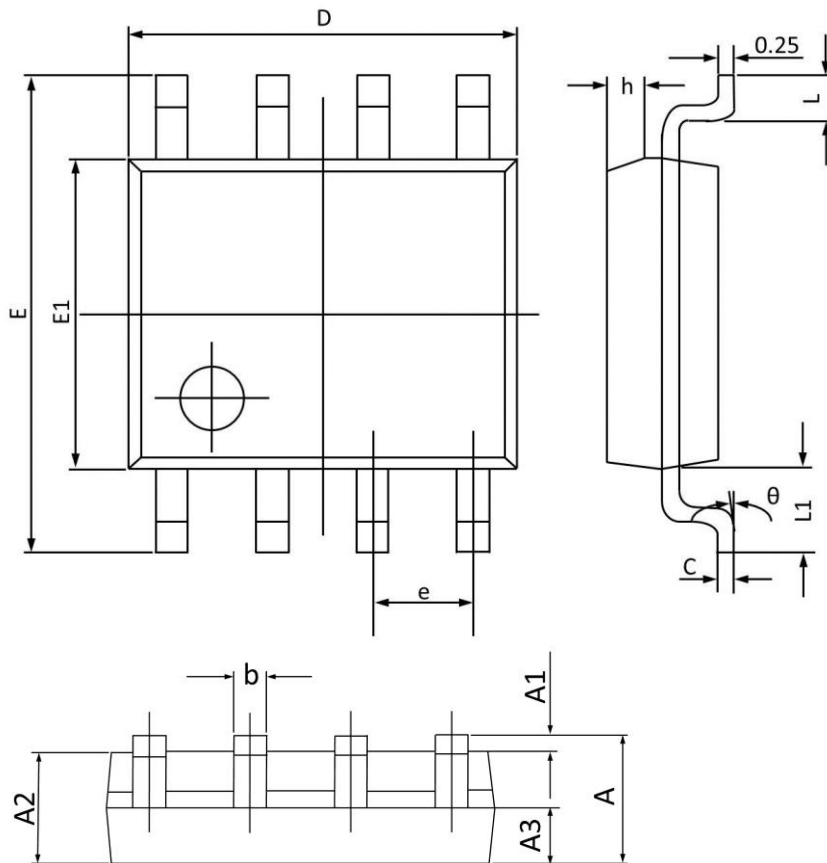

Fig.8 Gate Charge Waveform

Package Outline Dimensions

SOP-8



Symbol	Dimensions In Millimeters		Dimensions In Inches	
	Min	Max	Min	Max
A	1.350	1.750	0.053	0.068
A1	0.100	0.250	0.004	0.009
A2	1.300	1.500	0.052	0.059
A3	0.600	0.700	0.024	0.027
b	0.390	0.480	0.016	0.018
c	0.210	0.260	0.009	0.010
D	4.700	5.100	0.186	0.200
E	5.800	6.200	0.229	0.244
E1	3.700	4.100	0.146	0.161
e	1.270(BSC)		0.050(BSC)	
h	0.250	0.500	0.010	0.019
L	0.500	0.800	0.019	0.031
L1	1.050(BSC)		0.041(BSC)	
θ	0°	8°	0°	8°