

Main Product Characteristics

BV_{DSS}	100V
$R_{DS(ON)}$	18m Ω
I_D	40A

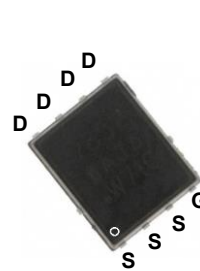

PPAK5X6

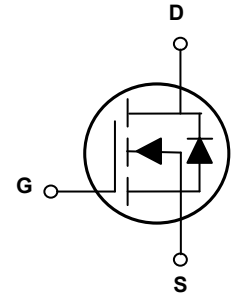

Schematic Diagram

Features and Benefits

- Advanced MOSFET process technology
- Ideal for high efficiency switched mode power supplies
- Low on-resistance with low gate charge
- Fast switching and reverse body recovery



Description

The GSFP1040 utilizes the latest techniques to achieve high cell density and low on-resistance. These features make this device extremely efficient and reliable for use in high efficiency switch mode power supply and a wide variety of other applications.

Absolute Maximum Ratings ($T_C=25^\circ\text{C}$ unless otherwise specified)

Parameter	Symbol	Max.	Unit
Drain-Source Voltage	V_{DS}	100	V
Gate-Source Voltage	V_{GS}	± 20	V
Drain Current-Continuous ($T_C=25^\circ\text{C}$)	I_D	40	A
Drain Current-Continuous ($T_C=100^\circ\text{C}$)		26	
Drain Current-Pulsed ¹	I_{DM}	160	A
Single Pulse Avalanche Energy ²	E_{AS}	76	mJ
Single Pulse Avalanche Current ²	I_{AS}	39	A
Power Dissipation ($T_C=25^\circ\text{C}$)	P_D	83	W
Power Dissipation-Derate above 25°C		0.66	
Thermal Resistance, Junction-to-Ambient	$R_{\theta JA}$	62	$^\circ\text{C}/\text{W}$
Thermal Resistance, Junction-to-Case	$R_{\theta JC}$	1.51	$^\circ\text{C}/\text{W}$
Operating Junction Temperature Range	T_J	-55 To +150	$^\circ\text{C}$
Storage Temperature Range	T_{STG}	-55 To +150	$^\circ\text{C}$

Electrical Characteristics ($T_J=25^\circ\text{C}$ unless otherwise specified)

Parameter	Symbol	Conditions	Min.	Typ.	Max.	Unit
On/Off Characteristics						
Drain-Source Breakdown Voltage	BV_{DSS}	$V_{GS}=0V, I_D=250\mu A$	100	-	-	V
Drain-Source Leakage Current	I_{DSS}	$V_{DS}=80V, V_{GS}=0V, T_J=25^\circ\text{C}$	-	-	1	μA
		$V_{DS}=80V, V_{GS}=0V, T_J=85^\circ\text{C}$	-	-	10	
Gate-Source Leakage Current	I_{GSS}	$V_{GS}=\pm 20V, V_{DS}=0V$	-	-	± 100	nA
Static Drain-Source On-Resistance ³	$R_{DS(ON)}$	$V_{GS}=10V, I_D=15A$	-	15	18	m Ω
Gate Threshold Voltage	$V_{GS(th)}$	$V_{GS}=V_{DS}, I_D=250\mu A$	2	3	4	V
Forward Transconductance	g_{fs}	$V_{DS}=10V, I_D=3A$	-	6	-	S
Dynamic and Switching Characteristics						
Total Gate Charge ^{3,4}	Q_g	$V_{DS}=50V, I_D=20A, V_{GS}=10V$	-	11.4	18	nC
Gate-Source Charge ^{3,4}	Q_{gs}		-	2.6	4	
Gate-Drain Charge ^{3,4}	Q_{gd}		-	4	6	
Turn-On Delay Time ^{3,4}	$t_{d(on)}$	$V_{DD}=50V, R_G=6\Omega, V_{GS}=10V, I_D=20A$	-	4.8	7.2	nS
Rise Time ^{3,4}	t_r		-	12.5	19	
Turn-Off Delay Time ^{3,4}	$t_{d(off)}$		-	27.6	42	
Fall Time ^{3,4}	t_f		-	8.2	13	
Input Capacitance	C_{iss}	$V_{DS}=50V, V_{GS}=0V, F=1\text{MHz}$	-	865	1300	pF
Output Capacitance	C_{oss}		-	175	260	
Reverse Transfer Capacitance	C_{rss}		-	6	10	
Gate Resistance	R_g	$V_{GS}=0V, V_{DS}=0V, F=1\text{MHz}$	-	0.9	-	Ω
Drain-Source Diode Characteristics and Maximum Ratings						
Continuous Source Current	I_S	$V_G=V_D=0V, \text{Force Current}$	-	-	40	A
Pulsed Source Current	I_{SM}		-	-	80	A
Diode Forward Voltage	V_{SD}	$V_{GS}=0V, I_S=1A, T_J=25^\circ\text{C}$	-	-	1	V
Reverse Recovery Time	t_{rr}	$V_R=100V, I_S=10A, di/dt=100A/\mu s, T_J=25^\circ\text{C}$	-	130	-	nS
Reverse Recovery Charge	Q_{rr}		-	180	-	nC

Note:

1. Repetitive rating: Pulsed width limited by maximum junction temperature.
2. $V_{DD}=50V, V_{GS}=10V, L=0.1\text{mH}, I_{AS}=39A, R_G=25\Omega, \text{starting } T_J=25^\circ\text{C}$.
3. Pulse test: pulse width $\leq 300\mu s, \text{duty cycle} \leq 2\%$.
4. Essentially independent of operation temperature.

Typical Electrical and Thermal Characteristic Curves

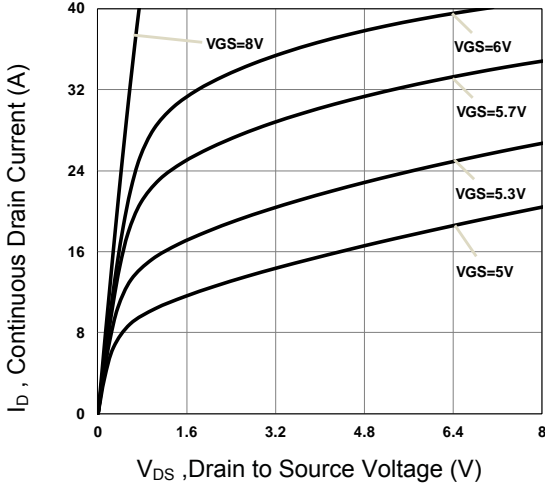

Figure 1. Typical Output Characteristics

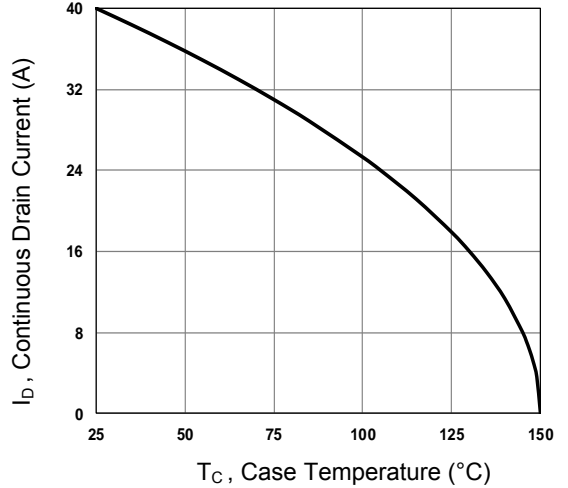

Figure 2. Continuous Drain Current vs. T_C

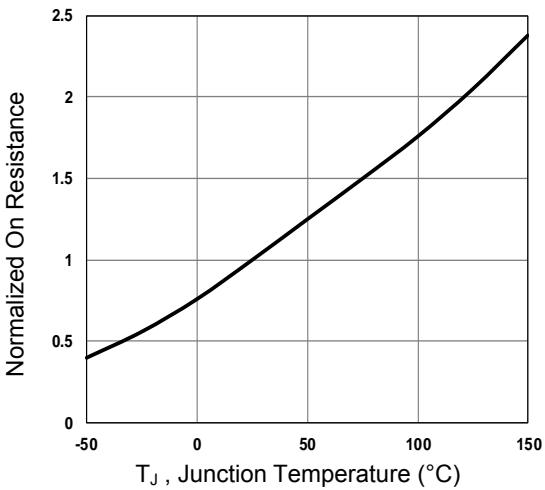

Figure 3. Normalized R_{DSON} vs. T_J

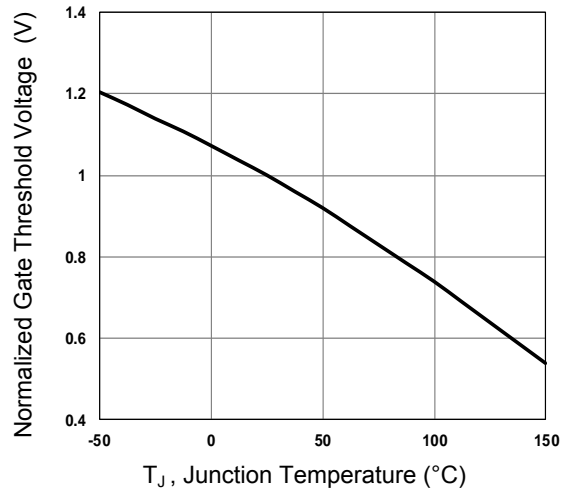

Figure 4. Normalized V_{th} vs. T_J

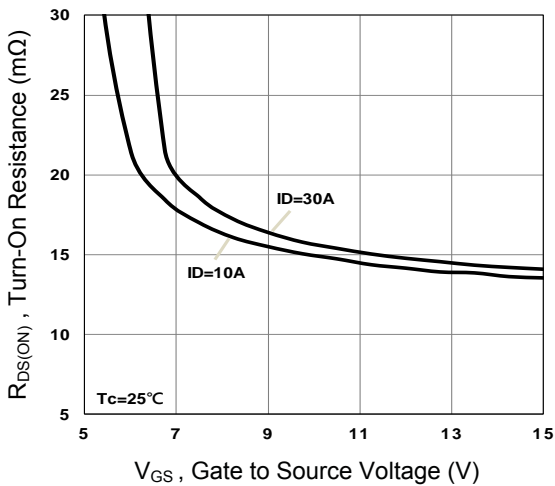

Figure 5. Turn-On Resistance vs. V_{GS}

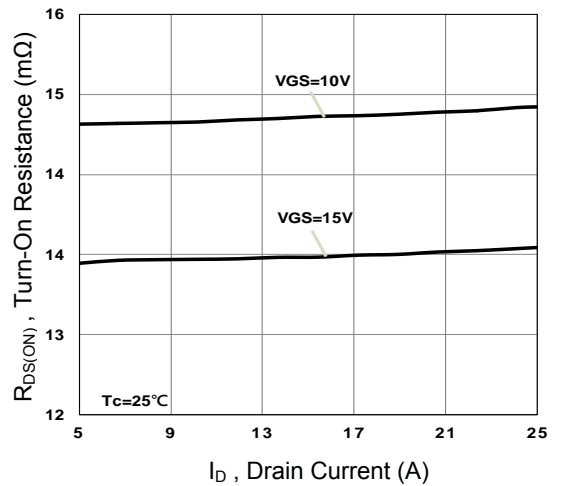

Figure 6. Turn-On Resistance vs. I_D

Typical Electrical and Thermal Characteristic Curves

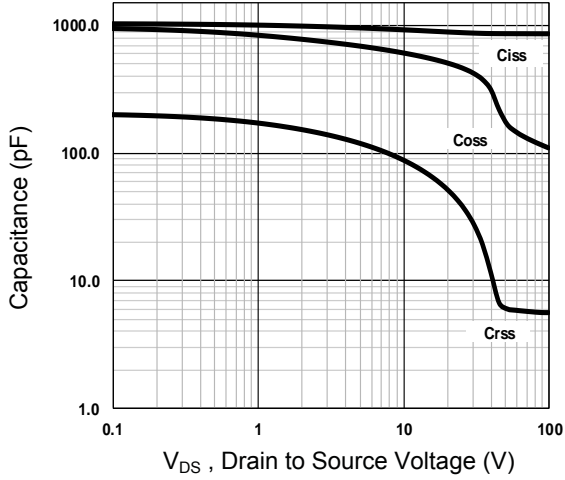

Figure 7. Capacitance Characteristics

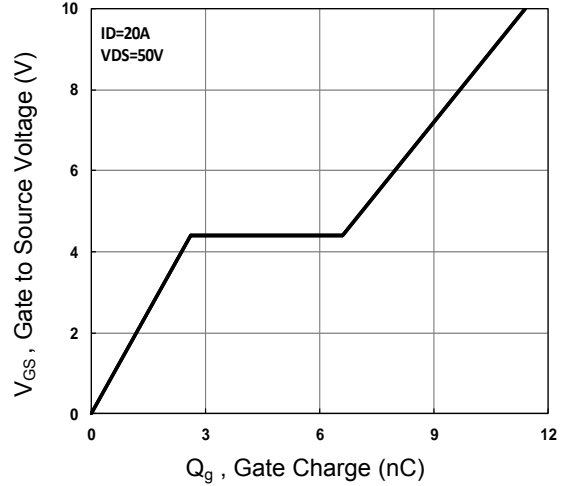

Figure 8. Gate Charge Waveform

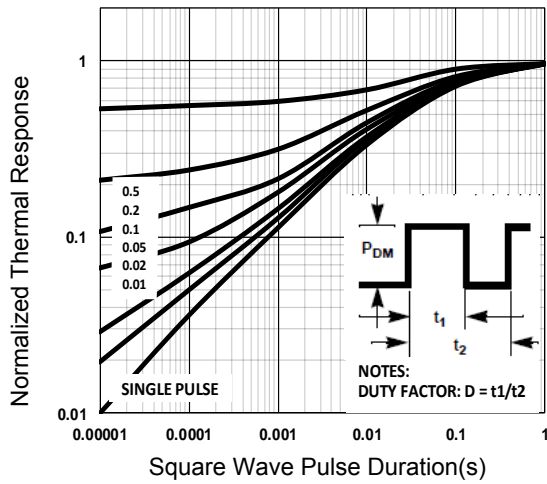

Figure 9. Normalized Transient Impedance

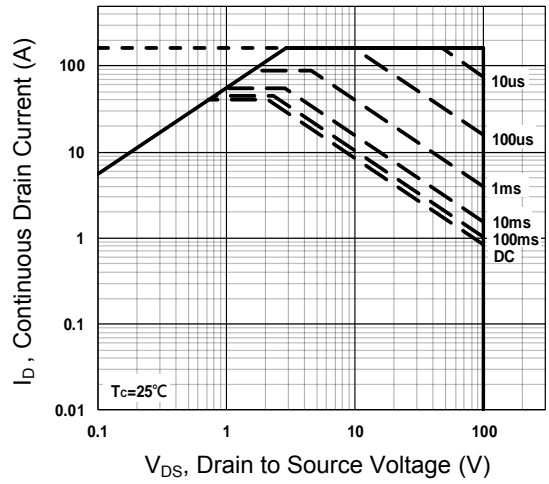

Figure 10. Maximum Safe Operation Area

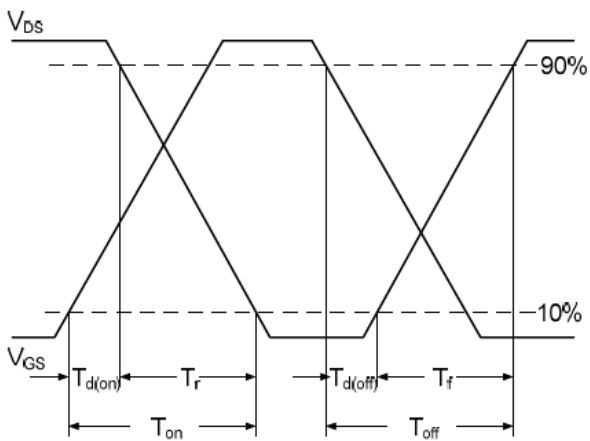

Figure 11. Switching Time Waveform

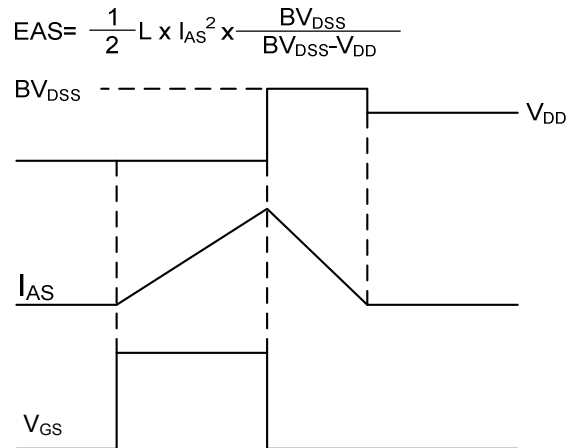
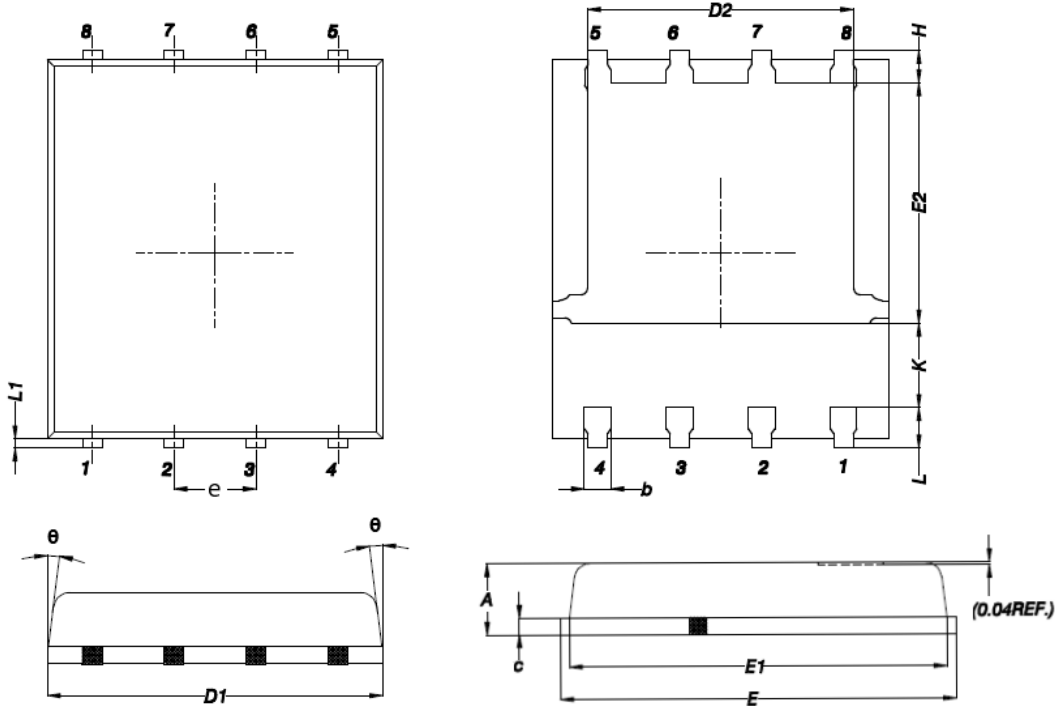

Figure 12. EAS Waveform

Package Outline Dimensions (PPAK5x6)



Symbol	Dimensions In Millimeters		Dimensions In Inches	
	MAX	MIN	MAX	MIN
A	1.200	0.850	0.047	0.031
b	0.510	0.330	0.020	0.012
C	0.300	0.200	0.012	0.008
D1	5.400	4.800	0.212	0.189
D2	4.310	3.610	0.170	0.142
E	6.300	5.850	0.248	0.230
E1	5.960	5.450	0.235	0.215
E2	3.920	3.300	0.154	0.130
e	1.27BSC		0.05BSC	
H	0.650	0.380	0.026	0.015
K	---	1.100	---	0.043
L	0.710	0.380	0.028	0.015
L1	0.250	0.050	0.009	0.002
θ	12°	0°	12°	0°