

Main Product Characteristics

BV_{DSS}	-30V
$R_{DS(ON)}$	19m Ω
I_D	-35A

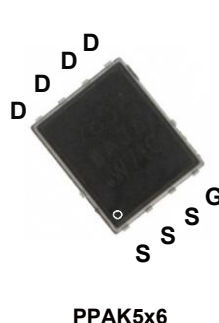

PPAK5x6

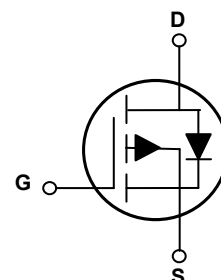

Schematic Diagram

Features and Benefits

- Advanced MOSFET process technology
- Ideal for high efficiency switched mode power supplies
- Low on-resistance with low gate charge
- Fast switching and reverse body recovery



Description

The GSFP0335 utilizes the latest techniques to achieve high cell density and low on-resistance. These features make this device extremely efficient and reliable for use in high efficiency switch mode power supply and a wide variety of other applications.

Absolute Maximum Ratings ($T_C=25^\circ\text{C}$ unless otherwise specified)

Parameter	Symbol	Max.	Unit
Drain-Source Voltage	V_{DS}	-30	V
Gate-Source Voltage	V_{GS}	± 20	V
Drain Current-Continuous ($T_C=25^\circ\text{C}$)	I_D	-35	A
Drain Current-Continuous ($T_C=100^\circ\text{C}$)		-22	A
Drain Current-Pulsed ¹	I_{DM}	-140	A
Single Pulse Avalanche Energy ²	E_{AS}	54	mJ
Single Pulse Avalanche Current ²	I_{AS}	-33	A
Power Dissipation ($T_C=25^\circ\text{C}$)	P_D	53	W
Power Dissipation-Derate Above 25 $^\circ\text{C}$		0.427	W/ $^\circ\text{C}$
Thermal Resistance, Junction-to-Ambient	$R_{\theta JA}$	62	$^\circ\text{C}/\text{W}$
Thermal Resistance, Junction-to-Case	$R_{\theta JC}$	2.34	$^\circ\text{C}/\text{W}$
Storage Temperature Range	T_{STG}	-55 To +150	$^\circ\text{C}$
Operating Junction Temperature Range	T_J	-55 To +150	$^\circ\text{C}$

Electrical Characteristics (T_J=25°C unless otherwise specified)

Parameter	Symbol	Conditions	Min.	Typ.	Max.	Unit
Off Characteristics						
Drain-Source Breakdown Voltage	BV _{DSS}	V _{GS} =0V, I _D =-250μA	-30	-	-	V
Drain-Source Leakage Current	I _{DSS}	V _{DS} =-30V, V _{GS} =0V, T _J =25°C	-	-	-1	μA
		V _{DS} =-24V, V _{GS} =0V, T _J =125°C	-	-	-10	μA
Gate-Source Leakage Current	I _{GSS}	V _{GS} =±20V, V _{DS} =0V	-	-	±100	nA
On Characteristics						
Static Drain-Source On-Resistance	R _{DS(ON)}	V _{GS} =-10V, I _D =-8A	-	16.5	19	mΩ
		V _{GS} =-4.5V, I _D =-5A	-	26	31	mΩ
Gate Threshold Voltage	V _{GS(th)}	V _{DS} =V _{GS} , I _D =-250μA	-1.2	-1.6	-2.5	V
Forward Transconductance	g _{fs}	V _{DS} =-10V, I _S =-3A	-	12	-	S
Dynamic and Switching Characteristics						
Total Gate Charge ^{2,3}	Q _g	V _{DS} =-15V, I _D =-10A, V _{GS} =-20V	-	17	26	nC
Gate-Source Charge ^{2,3}	Q _{gs}		-	3	4.5	
Gate-Drain Charge ^{2,3}	Q _{gd}		-	4	6.5	
Turn-On Delay Time ^{2,3}	t _{d(on)}	V _{DD} =-15V, R _G =25Ω, V _{GS} =-10V, I _D =-20A	-	7.2	11	nS
Rise Time ^{2,3}	t _r		-	38	57	
Turn-Off Delay Time ^{2,3}	t _{d(off)}		-	34	51	
Fall Time ^{2,3}	t _f		-	8.2	12	
Input Capacitance	C _{iss}	V _{DS} =-15V, V _{GS} =0V, F=1MHz	-	1100	1650	pF
Output Capacitance	C _{oss}		-	170	255	
Reverse Transfer Capacitance	C _{rss}		-	120	180	
Gate Resistance	R _g	V _{GS} =0V, V _{DS} =0V, F=1MHz	-	11	-	Ω
Drain-Source Diode Characteristics and Maximum Ratings						
Continuous Source Current	I _S	V _G =V _D =0V, Force Current	-	-	-35	A
Pulsed Source Current	I _{SM}		-	-	-70	A
Diode Forward Voltage	V _{SD}	V _{GS} =0V, I _S =-1A, T _J =25°C	-	-	-1	V
Reverse Recovery Time	T _{rr}	V _R =-30V, I _S =-10A, di/dt=100A/μs, T _J =25°C	-	150	-	nS
Reverse Recovery Charge	Q _{rr}		-	250	-	nC

Note:

1. Repetitive rating: Pulsed width limited by maximum junction temperature.
2. V_{DD}=-25V, V_{GS}=-10V, L=0.1mH, I_{AS}=-33A, starting T_J=25°C.
3. Pluse test: pulse width ≤ 300us, duty cycle ≤ 2%.
4. Essentially independent of operation temperature.

Typical Electrical and Thermal Characteristic Curves

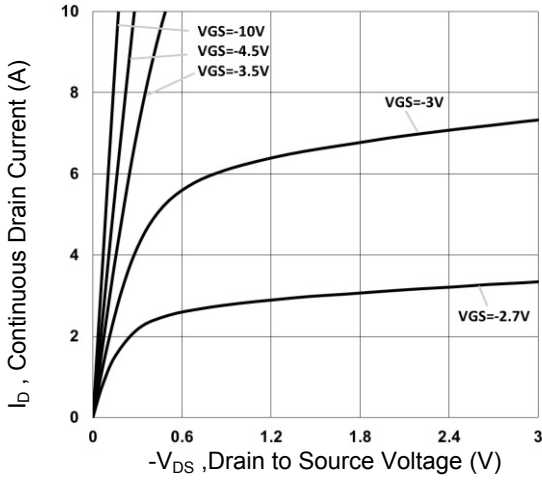

Fig.1 Typical Output Characteristics

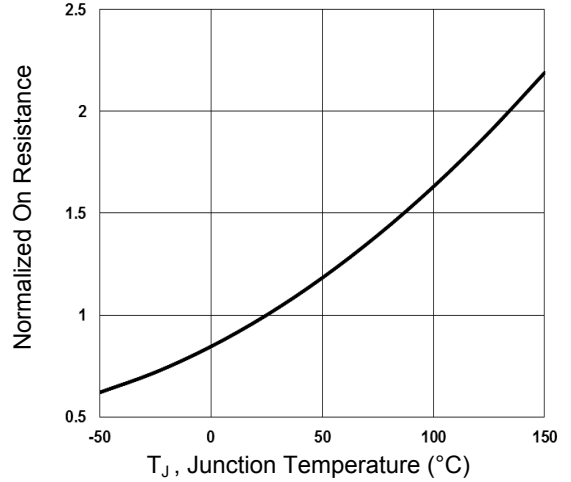

Fig.2 Normalized $R_{DS(ON)}$ vs. T_J

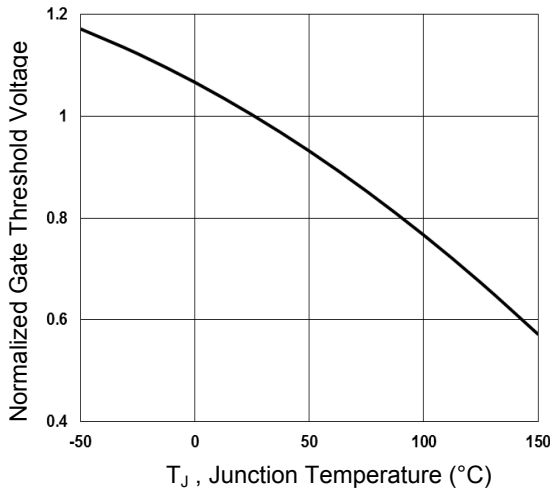

Fig.3 Normalized V_{th} vs. T_J

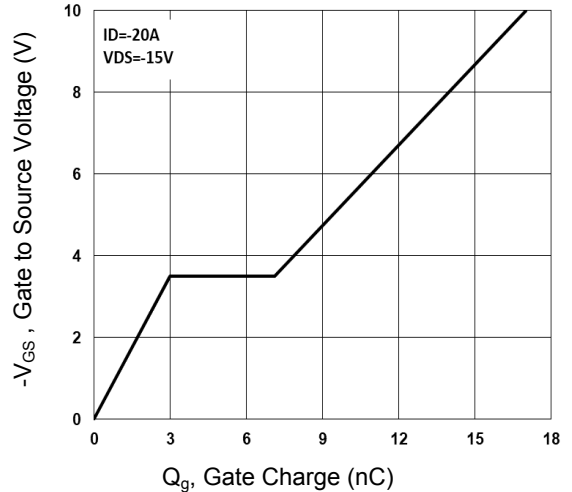

Fig.4 Gate Charge Waveform

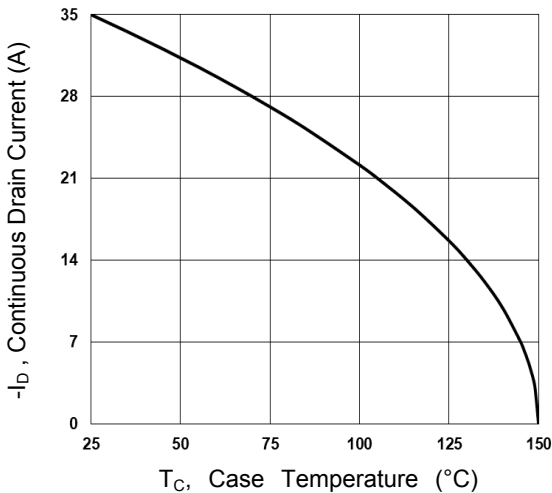

Fig.5 Continuous Drain Current vs. T_C

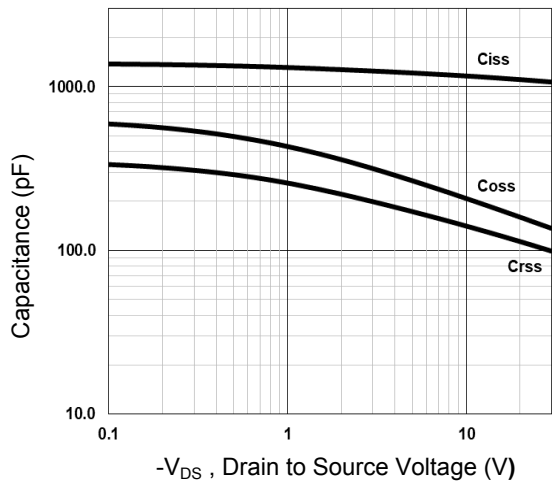

Fig.6 Capacitance Characteristics

Typical Electrical and Thermal Characteristic Curves

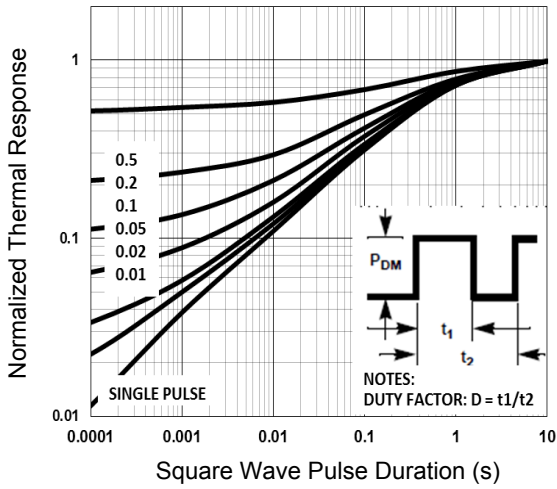

Fig.7 Normalized Transient Impedance

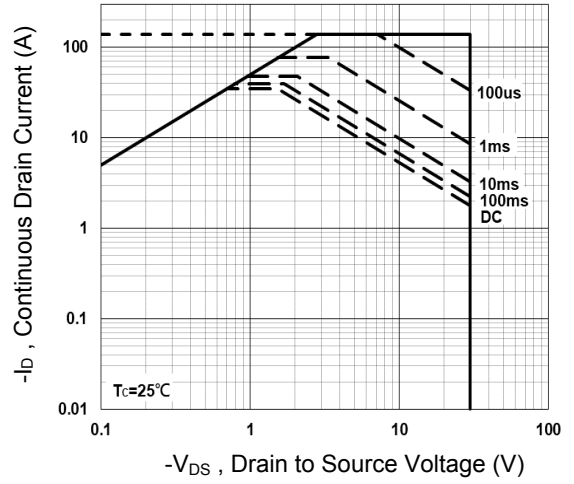

Fig.8 Maximum Safe Operation Area

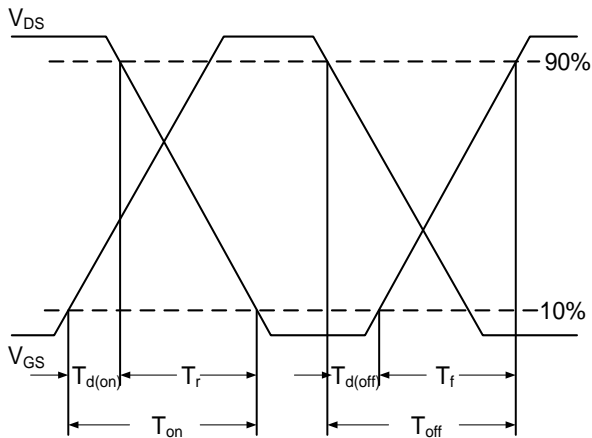

Fig.9 Switching Time Waveform

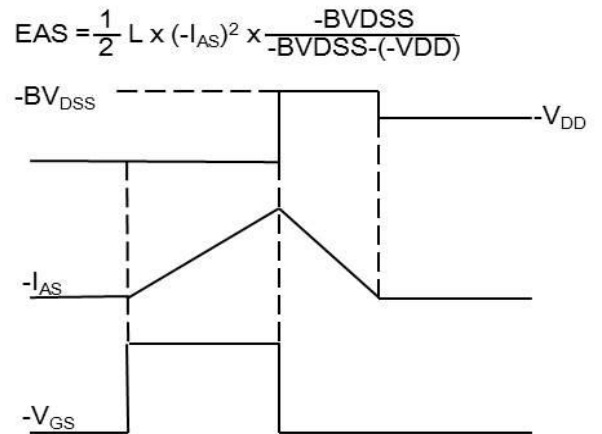
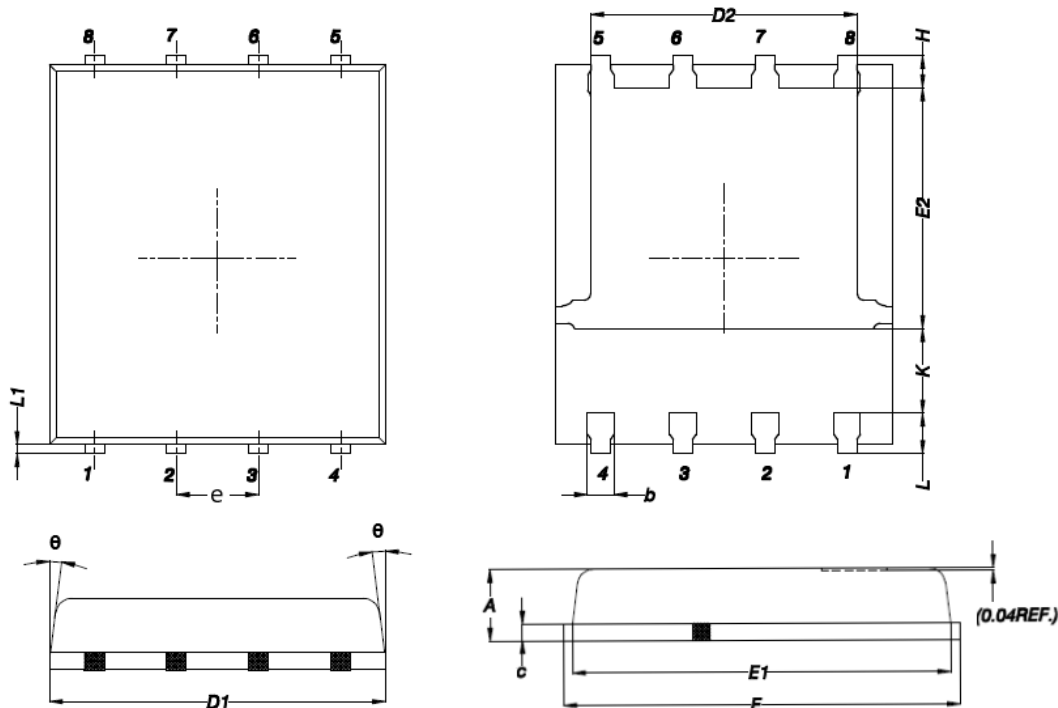

Fig.10 EAS Waveform

Package Outline Dimensions

PPAK5x6



Symbol	Dimensions In Millimeters		Dimensions In Inches	
	MAX	MIN	MAX	MIN
A	1.200	0.850	0.047	0.031
b	0.510	0.300	0.020	0.012
C	0.300	0.200	0.012	0.008
D1	5.400	4.800	0.212	0.189
D2	4.310	3.610	0.170	0.142
E	6.300	5.850	0.248	0.230
E1	5.960	5.450	0.235	0.215
E2	3.920	3.300	0.154	0.130
e	1.27BSC		0.05BSC	
H	0.650	0.380	0.026	0.015
K	-	1.100	-	0.043
L	0.710	0.380	0.028	0.015
L1	0.250	0.050	0.009	0.002
θ	12°	0°	12°	0°