

Main Product Characteristics

BV_{DSS}	65V
$R_{DS(ON)}$	10.8m Ω
I_D	48A

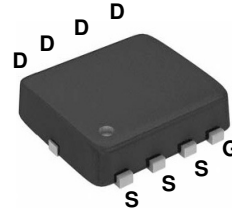

PPAK 3x3

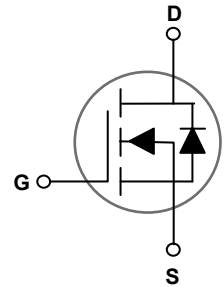

Schematic Diagram

Features and Benefits

- Advanced MOSFET process technology
- Ideal for high efficiency switched mode power supplies
- Low on-resistance with low gate charge
- Fast switching and reverse body recovery



Description

The GSFN0648 utilizes the latest techniques to achieve high cell density and low on-resistance. These features make this device extremely efficient and reliable for use in high efficiency switch mode power supply and a wide variety of other applications.

Absolute Maximum Ratings ($T_C=25^\circ\text{C}$ unless otherwise specified)

Parameter	Symbol	Max.	Unit
Drain-Source Voltage	V_{DS}	65	V
Gate-Source Voltage	V_{GS}	+20 / -12	V
Drain Current – Continuous ($T_C=25^\circ\text{C}$)	I_D	48	A
Drain Current – Continuous ($T_C=100^\circ\text{C}$)		30.4	A
Drain Current – Pulsed ¹	I_{DM}	192	A
Single Pulse Avalanced Energy ²	EAS	51.2	mJ
Single Pulse Avalanced Current ²	IAS	32	A
Power Dissipation ($T_C=25^\circ\text{C}$)	P_D	42	W
Power Dissipation – Derate above 25°C		0.33	W/ $^\circ\text{C}$
Storage Temperature Range	T_{STG}	-55 to +150	$^\circ\text{C}$
Operating Junction Temperature Range	T_J	-55 to +150	$^\circ\text{C}$
Thermal Resistance Junction to Ambient	$R_{\theta JA}$	62	$^\circ\text{C}/\text{W}$
Thermal Resistance Junction to Case	$R_{\theta JC}$	2.98	$^\circ\text{C}/\text{W}$

Electrical Characteristics ($T_J=25^\circ\text{C}$ unless otherwise specified)

Parameter	Symbol	Conditions	Min.	Typ.	Max.	Unit
Drain-Source Breakdown Voltage	BV_{DSS}	$V_{GS}=0V, I_D=250\mu A$	65	-	-	V
BV_{DSS} Temperature Coefficient	$\Delta BV_{DSS}/\Delta T_J$	Reference to 25°C , $I_D=1mA$	-	0.03	-	$V/^\circ\text{C}$
Drain-Source Leakage Current	I_{DSS}	$V_{DS}=60V, V_{GS}=0V,$ $T_J=25^\circ\text{C}$	-	-	1	μA
		$V_{DS}=48V, V_{GS}=0V,$ $T_J=85^\circ\text{C}$	-	-	10	μA
Gate-Source Leakage Current	I_{GSS}	$V_{GS}=+20V, V_{DS}=0V$	-	-	100	nA
Static Drain-Source On-Resistance ³	$R_{DS(ON)}$	$V_{GS}=10V, I_D=15A$	-	9	10.8	$m\Omega$
		$V_{GS}=4.5V, I_D=12A$	-	16.3	19.5	$m\Omega$
Gate Threshold Voltage	$V_{GS(th)}$	$V_{GS}=V_{DS}, I_D=250\mu A$	1	1.6	2.5	V
$V_{GS(th)}$ Temperature Coefficient	$\Delta V_{GS(th)}$		-	-5	-	$mV/^\circ\text{C}$
Forward Transconductance	gfs	$V_{DS}=10V, I_D=3A$	-	6	-	S
Total Gate Charge ^{3,4}	Q_g	$V_{DS}=30V, V_{GS}=10V,$ $I_D=15A$	-	15.3	30.6	nC
Gate-Source Charge ^{3,4}	Q_{gs}		-	2.4	5.8	
Gate-Drain Charge ^{3,4}	Q_{gd}		-	5.4	10.8	
Turn-On Delay Time ^{3,4}	$T_{d(on)}$	$V_{DD}=30V, V_{GS}=10V,$ $R_G=3.3\Omega, I_D=1A$	-	10	20	ns
Rise Time ^{3,4}	T_r		-	13.5	27	
Turn-Off Delay Time ^{3,4}	$T_{d(off)}$		-	28	56	
Fall Time ^{3,4}	T_f		-	20	40	
Input Capacitance	C_{iss}	$V_{DS}=30V, V_{GS}=0V,$ $F=1MHz$	-	945	1890	pF
Output Capacitance	C_{oss}		-	275	550	
Reverse Transfer Capacitance	C_{rss}		-	26	52	
Gate Resistance	R_g	$V_{GS}=0V,$ $V_{DS}=0V, F=1MHz$	-	0.3	-	Ω

Source-Drain Ratings and Characteristics

Parameter	Symbol	Conditions	Min.	Typ.	Max.	Unit
Continuous Source Current	$8I_S$	$V_G=V_D=0V,$ Force Current	-	-	48	A
Pulsed Source Current ³	I_{SM}		-	-	96	A
Diode Forward Voltage ³	V_{SD}	$V_{GS}=0V, I_S=1A,$ $T_J=25^\circ\text{C}$	-	-	1	V

Note :

1. Repetitive Rating : Pulsed width limited by maximum junction temperature.
2. $V_{DD}=50V, V_{GS}=10V, L=0.1mH, I_{AS}=32A, R_G=25\Omega, \text{Starting } T_J=25^\circ\text{C}.$
3. The data tested by pulsed , pulse width $\leq 300\mu s$, duty cycle $\leq 2\%$.
4. Essentially independent of operating temperature.

Typical Electrical and Thermal Characteristic Curves

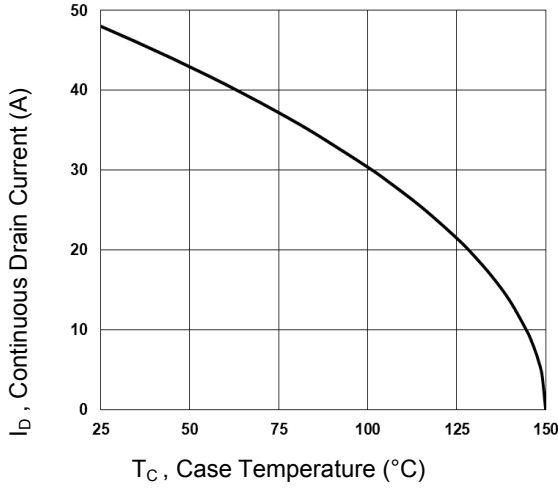

Figure 1. Continuous Drain Current vs. T_C

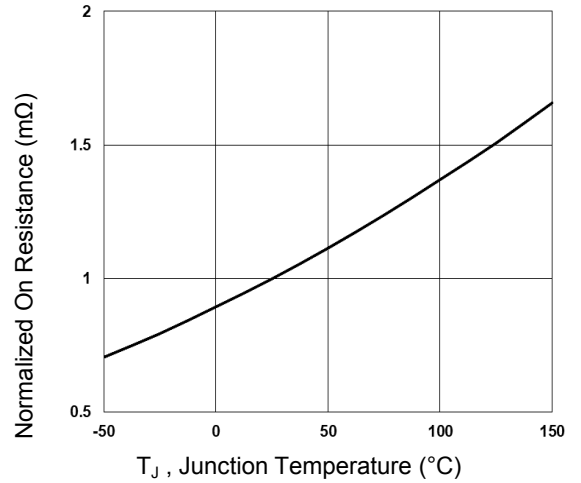

Figure 2. Normalized $R_{DS(ON)}$ vs. T_J

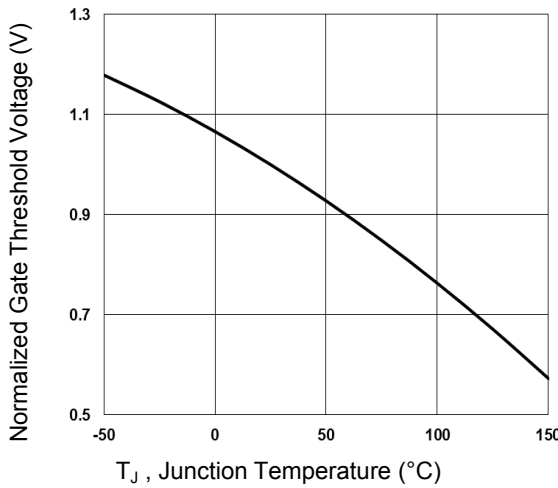

Figure 3. Normalized V_{th} vs. T_J

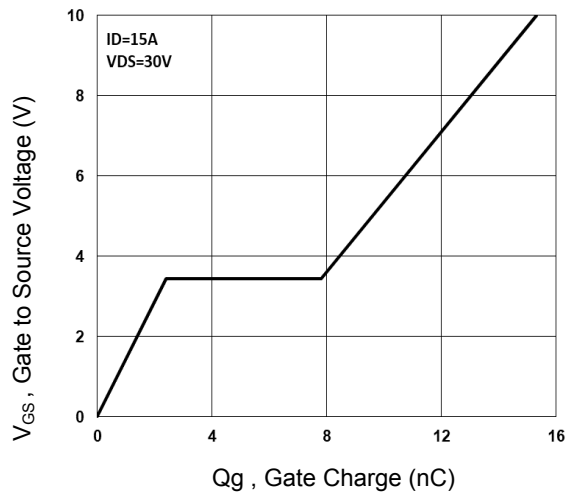

Figure 4. Gate Charge Waveform

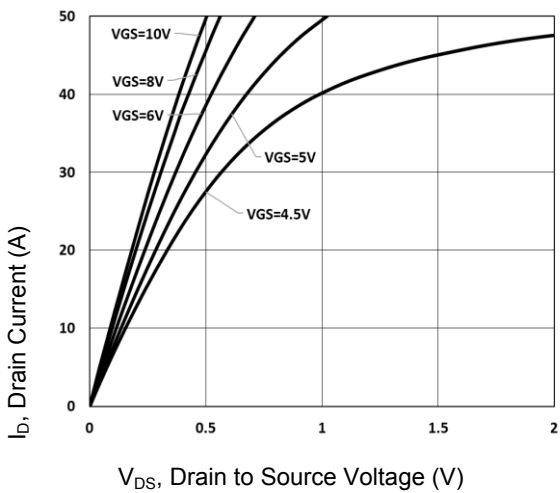

Figure 5. Typical Output Characteristics

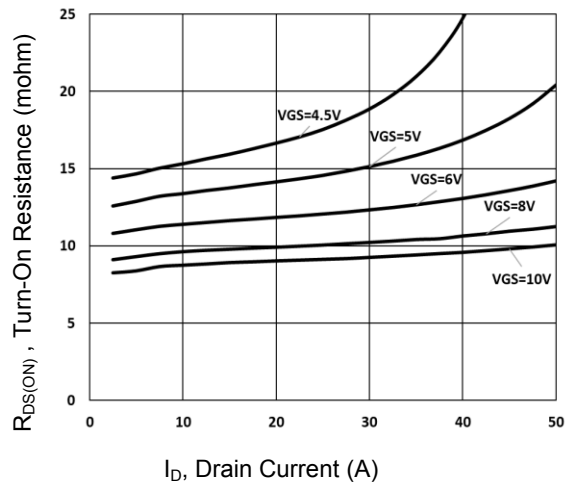

Figure 6. Turn-on Resistance vs. I_D

Typical Electrical and Thermal Characteristic Curves

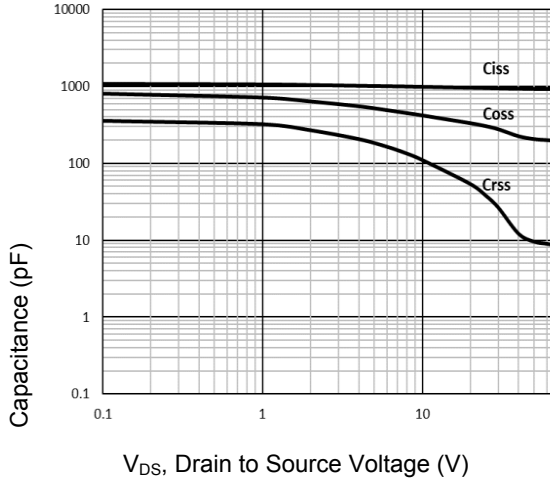

Figure 7. Capacitance Characteristics

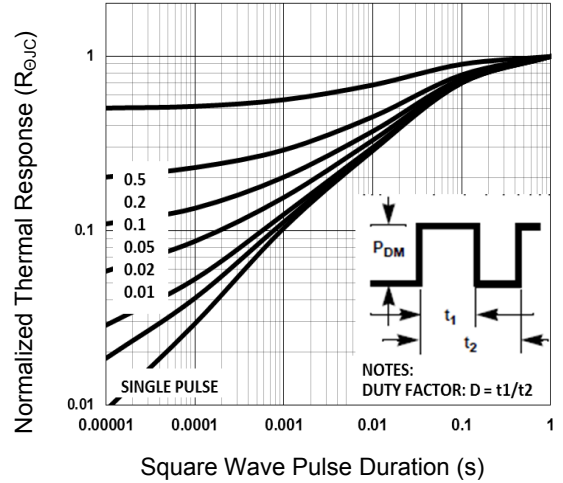

Figure 8. Normalized Transient Response

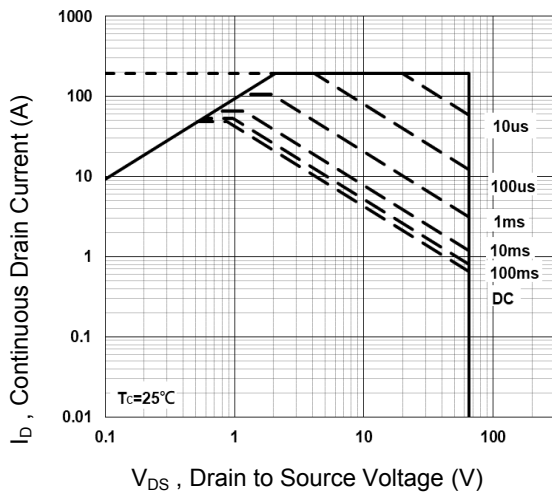

Figure 9. Maximum Safe Operation Area

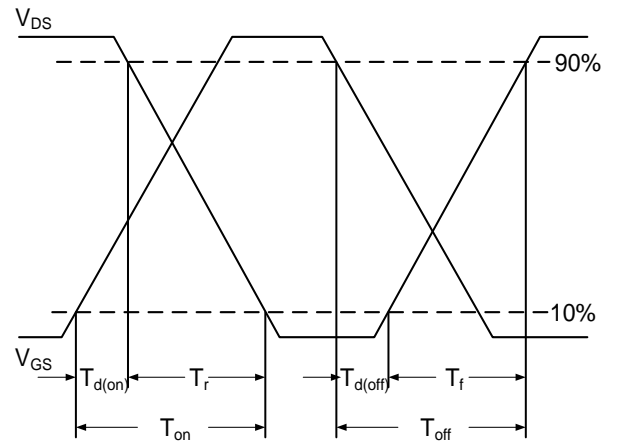

Figure 10. Switching Time Waveform

$$EAS = \frac{1}{2} L \times I_{AS}^2 \times \frac{BV_{DSS}}{BV_{DSS} - V_{DD}}$$

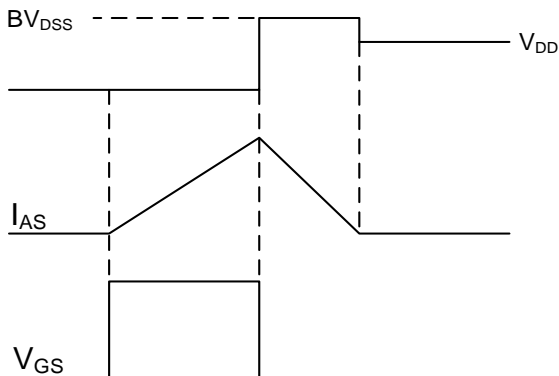
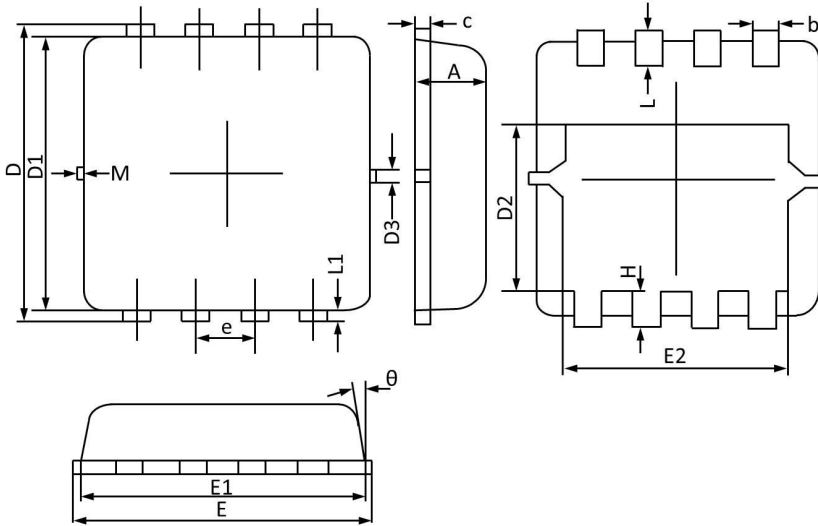

Figure 11. EAS Waveform

Package Outline Dimensions (PPAK 3x3)



Symbol	Dimensions In Millimeters		Dimensions In Inches	
	Min	Max	Min	Max
A	0.700	0.800	0.028	0.031
b	0.250	0.350	0.010	0.013
c	0.100	0.250	0.004	0.009
D	3.250	3.450	0.128	0.135
D1	3.000	3.200	0.119	0.125
D2	1.780	1.980	0.070	0.077
D3	0.130 REF		0.005 REF	
E	3.200	3.400	0.126	0.133
E1	3.000	3.200	0.119	0.125
E2	2.390	2.590	0.094	0.102
e	0.650BSC		0.026BSC	
H	0.300	0.500	0.011	0.019
L	0.300	0.500	0.011	0.019
L1	0.130 REF		0.005 REF	
theta	0°	12°	0°	12°
M	0.150 REF		0.006 REF	