

Main Product Characteristics

$V_{(BR)DSS}$	60V
$R_{DS(ON)}$	90mΩ (Max.)
I_D	5A

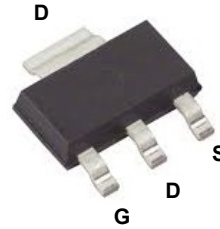

SOT-223

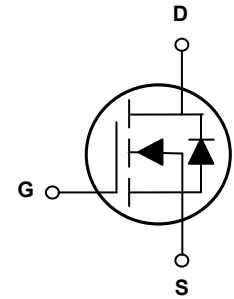

Schematic Diagram

Features and Benefits

- Advanced MOSFET process technology
- Ideal for high efficiency switched mode power supplies
- Low on-resistance with low gate charge
- Fast switching and reverse body recovery



Description

The GSFL6090 utilizes the latest techniques to achieve high cell density and low on-resistance. These features make this device extremely efficient and reliable for use in high efficiency switch mode power supplies and a wide variety of other applications.

Absolute Maximum Ratings ($T_C=25^{\circ}C$ unless otherwise specified)

Parameter	Symbol	Max.	Unit
Drain-Source Voltage	V_{DS}	60	V
Gate-Source Voltage	V_{GS}	±20	V
Drain Current-Continuous ($T_A=25^{\circ}C$)	I_D	5	A
Drain Current-Continuous ($T_A=70^{\circ}C$)		4	
Drain Current-Pulsed ¹	I_{DM}	20	A
Single Pulse Avalanche Energy ²	E_{AS}	8	mJ
Single Pulse Avalanche Current ²	I_{AS}	12.8	A
Power Dissipation ($T_A=25^{\circ}C$)	P_D	1.79	W
Power Dissipation-Derate above 25°C		0.014	
Thermal Resistance, Junction-to-Ambient	$R_{\theta JA}$	70	°C/W
Operating Junction Temperature Range	T_J	-55 To +150	°C
Storage Temperature Range	T_{STG}	-55 To +150	°C

Electrical Characteristics ($T_J=25^\circ\text{C}$ unless otherwise specified)

Parameter	Symbol	Conditions	Min.	Typ.	Max.	Unit
On / Off Characteristics						
Drain-Source Breakdown Voltage	BV_{DSS}	$V_{GS}=0V, I_D=250\mu A$	60	-	-	V
BV_{DSS} Temperature Coefficient	$\Delta BV_{DSS}/\Delta T_J$	Reference to 25°C , $I_D=1mA$	-	0.05	-	$V/^\circ\text{C}$
Drain-Source Leakage Current	I_{DSS}	$V_{DS}=60V, V_{GS}=0V, T_J=25^\circ\text{C}$	-	-	1	μA
		$V_{DS}=48V, V_{GS}=0V, T_J=125^\circ\text{C}$	-	-	10	μA
Gate-Source Leakage Current	I_{GSS}	$V_{GS}=\pm 20V, V_{DS}=0V$	-	-	± 100	nA
Static Drain-Source On-Resistance	$R_{DS(ON)}$	$V_{GS}=10V, I_D=5A$	-	75	90	m Ω
		$V_{GS}=4.5V, I_D=3A$	-	86	118	
Gate Threshold Voltage	$V_{GS(th)}$	$V_{GS}=V_{DS}, I_D=250\mu A$	1.2	1.8	2.5	V
$V_{GS(th)}$ Temperature Coefficient	$\Delta V_{GS(th)}$		-	-5	-	mV/ $^\circ\text{C}$
Forward Transconductance	gfs	$V_{DS}=10V, I_D=3A$	-	7	-	S
Dynamic and Switching Characteristics						
Total Gate Charge ^{2,3}	Q_g	$V_{DS}=30V, I_D=3A, V_{GS}=10V$	-	4.6	8	nC
Gate-Source Charge ^{2,3}	Q_{gs}		-	0.4	3	
Gate-Drain Charge ^{2,3}	Q_{gd}		-	2	4	
Turn-On Delay Time ^{2,3}	$t_{d(on)}$	$V_{DD}=30V, R_G=6\Omega, V_{GS}=10V, I_D=3A$	-	2.9	6	nS
Rise Time ^{2,3}	t_r		-	9.5	18	
Turn-Off Delay Time ^{2,3}	$t_{d(off)}$		-	18.4	35	
Fall Time ^{2,3}	t_f		-	5.3	10	
Input Capacitance	C_{iss}	$V_{DS}=30V, V_{GS}=0V, F=1MHz$	-	360	540	pF
Output Capacitance	C_{oss}		-	30	45	
Reverse Transfer Capacitance	C_{rss}		-	20	30	
Gate Resistance	R_g	$V_{GS}=0V, V_{DS}=0V, F=1MHz$	-	2	4	Ω
Source-Drain Ratings and Characteristics						
Continuous Source Current	I_S	$V_G=V_D=0V,$	-	-	5	A
Pulsed Source Current	I_{SM}	Force Current	-	-	20	A
Diode Forward Voltage	V_{SD}	$V_{GS}=0V, I_S=1A, T_J=25^\circ\text{C}$	-	-	1	V
Reverse Recovery Time ²	T_{rr}	$V_R=50V, I_S=3A, di/dt=100A/\mu s, T_J=25^\circ\text{C}$	-	25	-	nS
Reverse Recovery Charge ²	Q_{rr}		-	15	-	nC

Notes:

1. Repetitive rating: Pulsed width limited by maximum junction temperature.
2. $V_{DD}=25V, V_{GS}=10V, L=0.1mH, I_{AS}=12.8A, R_G=25\Omega$, starting $T_J=25^\circ\text{C}$.
3. Pulse test: pulse width $\leq 300\mu s$, duty cycle $\leq 2\%$.
4. Essentially independent of operation temperature.

Typical Electrical and Thermal Characteristic Curves

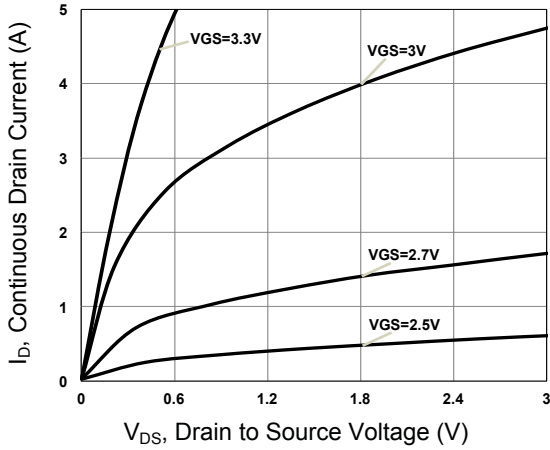

Figure 1. Typical Output Characteristics

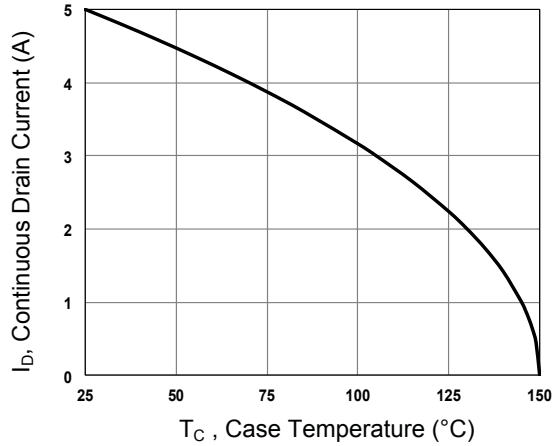

Figure 2. Continuous Drain Current vs. T_C

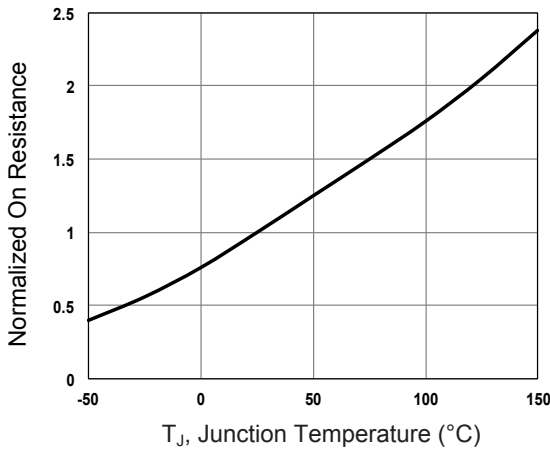

Figure 3. Normalized $R_{DS(ON)}$ vs. T_J

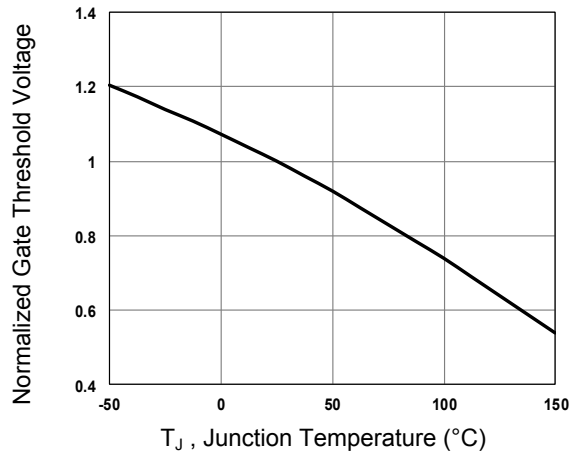

Figure 4. Normalized V_{th} vs. T_J

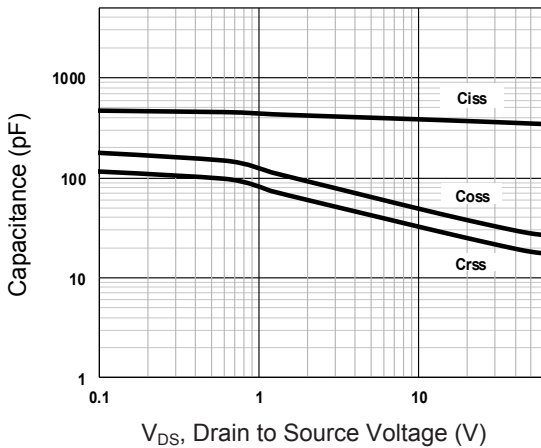

Figure 5. Capacitance Characteristics

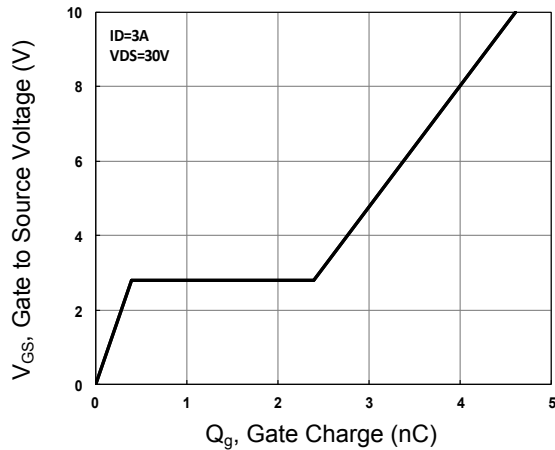

Figure 6. Gate Charge Characteristics

Typical Electrical and Thermal Characteristic Curves

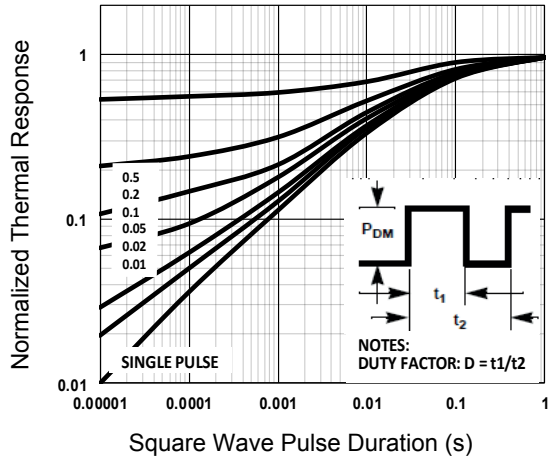

Figure 7. Normalized Transient Impedance

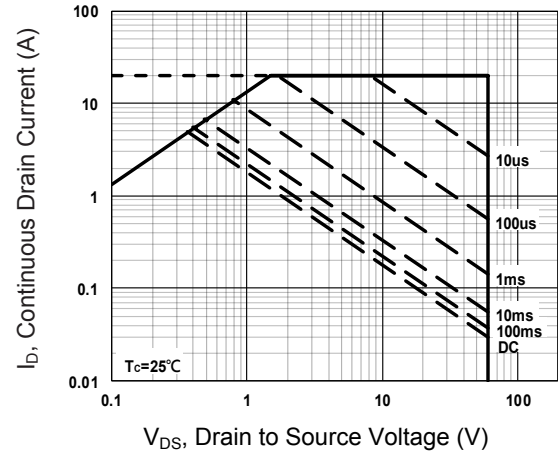
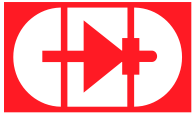
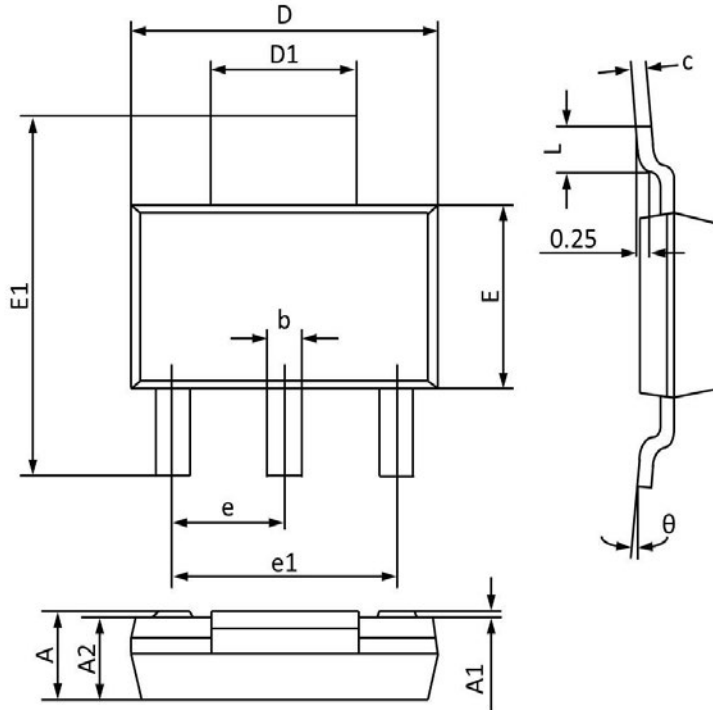

Figure 8. Maximum Safe Operation Area



Package Outline Dimensions (SOT-223)



Symbol	Dimensions In Millimeters		Dimensions In Inches	
	Min	Max	Min	Max
A	1.50	1.80	0.060	0.071
A1	0.00	0.12	0.000	0.005
A2	1.45	1.75	0.057	0.069
b	0.60	0.82	0.024	0.032
c	0.20	0.35	0.008	0.014
D	6.20	6.70	0.244	0.264
D1	2.90	3.10	0.114	0.122
E	3.30	3.70	0.130	0.146
E1	6.70	7.30	0.264	0.287
e	2.30 BSC		0.091 BSC	
e1	4.40	4.70	0.173	0.185
L	0.90	1.15	0.035	0.045
θ	0°	10°	0°	10°

Order Information

Device	Package	Marking	Carrier	Quantity
GSFL6090	SOT-223	L6090	Tape & Reel	3,000pcs / Reel