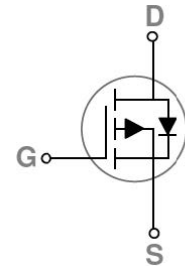
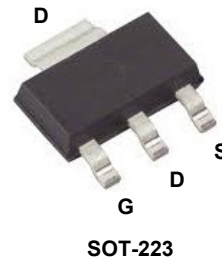


### Main Product Characteristics

$BV_{DSS}$	-40V
$R_{DS(ON)}$	68m $\Omega$
$I_D$	-3.5A



Schematic Diagram

### Features and Benefits

- Advanced MOSFET process technology
- Ideal for high efficiency switched mode power supplies
- Low on-resistance with low gate charge
- Fast switching and reverse body recovery



### Description

The GSFL0403 utilizes the latest techniques to achieve high cell density and low on-resistance. These features make this device extremely efficient and reliable for use in high efficiency switch mode power supply and a wide variety of other applications.

### Absolute Maximum Ratings (T<sub>C</sub>=25°C unless otherwise specified)

Parameter	Symbol	Max.	Unit
Drain-Source Voltage	$V_{DS}$	-40	V
Gate-Source Voltage	$V_{GS}$	$\pm 20$	V
Drain Current-Continuous(T <sub>A</sub> =25°C)	$I_D$	-3.5	A
Drain Current-Continuous(T <sub>A</sub> =70°C)		-2.8	A
Drain Current-Pulsed <sup>1</sup>	$I_{DM}$	-14	A
Power Dissipation(T <sub>A</sub> =25°C)	$P_D$	1.78	W
Power Dissipation-Derate Above 25°C		0.014	W/°C
Thermal Resistance, Junction-to-Ambient	$R_{\theta JA}$	70	°C/W
Storage Temperature Range	$T_{STG}$	-55 To +150	°C
Operating Junction Temperature Range	$T_J$	-55 To +150	°C

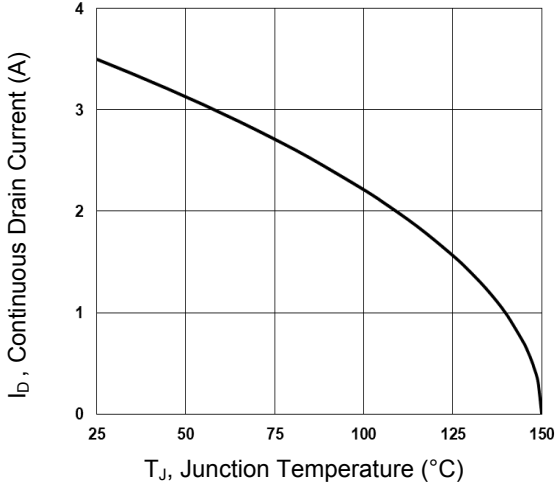
### Electrical Characteristics ( $T_J=25^\circ\text{C}$ unless otherwise specified)

Parameter	Symbol	Conditions	Min.	Typ.	Max.	Unit
<b>Off Characteristics</b>						
Drain-Source Breakdown Voltage	$BV_{DSS}$	$V_{GS}=0V, I_D=-250\mu A$	-40	-	-	V
Drain-Source Leakage Current	$I_{DSS}$	$V_{DS}=-40V, V_{GS}=0V, T_J=25^\circ\text{C}$	-	-	-1	$\mu A$
		$V_{DS}=-32V, V_{GS}=0V, T_J=125^\circ\text{C}$	-	-	-10	$\mu A$
Gate-Source Leakage Current	$I_{GSS}$	$V_{GS}=\pm 20V, V_{DS}=0V$	-	-	$\pm 100$	nA
<b>On Characteristics</b>						
Static Drain-Source On-Resistance	$R_{DS(ON)}$	$V_{GS}=-10V, I_D=-2A$	-	55	68	m $\Omega$
		$V_{GS}=-4.5V, I_D=-1A$	-	75	100	
Gate Threshold Voltage	$V_{GS(th)}$	$V_{DS}=V_{GS}, I_D=-250\mu A$	-1	-1.65	-2.5	V
Forward Transconductance	$g_{FS}$	$V_{DS}=-10V, I_D=-1A$	-	3	-	S
<b>Dynamic and Switching Characteristics</b>						
Total Gate Charge <sup>2,3</sup>	$Q_g$	$V_{DS}=-32V, I_D=-10A, V_{GS}=-2V$	-	6.4	-	nC
Gate-Source Charge <sup>2,3</sup>	$Q_{gs}$		-	0.5	-	
Gate-Drain Charge <sup>2,3</sup>	$Q_{gd}$		-	2.7	-	
Turn-On Delay Time <sup>2,3</sup>	$t_{d(on)}$	$V_{DD}=-20V, R_G=6\Omega, V_{GS}=-10V, I_D=-1A$	-	12	-	nS
Rise Time <sup>2,3</sup>	$t_r$		-	9	-	
Turn-Off Delay Time <sup>2,3</sup>	$t_{d(off)}$		-	45	-	
Fall Time <sup>2,3</sup>	$t_f$		-	5	-	
Input Capacitance	$C_{iss}$	$V_{DS}=-25V, V_{GS}=-10V, F=1\text{MHz}$	-	600	-	pF
Output Capacitance	$C_{oss}$		-	60	-	
Reverse Transfer Capacitance	$C_{rss}$		-	43	-	
<b>Drain-Source Diode Characteristics and Maximum Ratings</b>						
Continuous Source Current	$I_S$	$V_G=V_D=0V,$	-	-	-3.5	A
Pulsed Source Current	$I_{SM}$	Force Current	-	-	-7	A
Diode Forward Voltage	$V_{SD}$	$V_{GS}=0V, I_S=-1A, T_J=25^\circ\text{C}$	-	-	-1	V

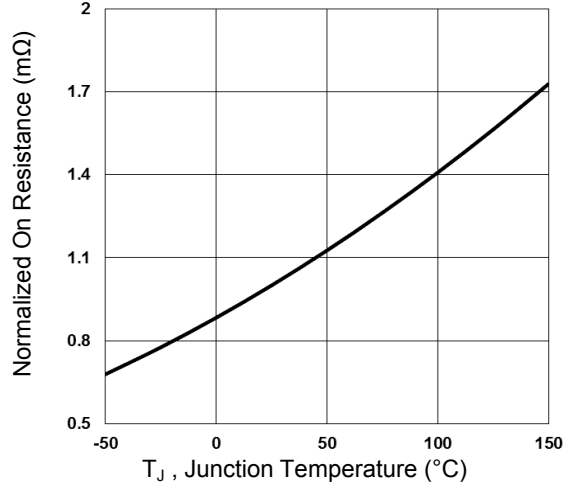
Note :

1. Repetitive Rating : Pulsed width limited by maximum junction temperature.
2. The data tested by pulsed , pulse width  $\leq 300\mu s$  , duty cycle  $\leq 2\%$ .
3. Essentially independent of operating temperature.

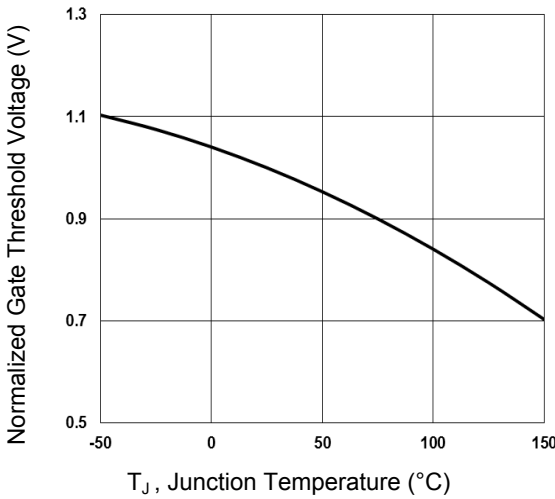
**Typical Electrical and Thermal Characteristic Curves**



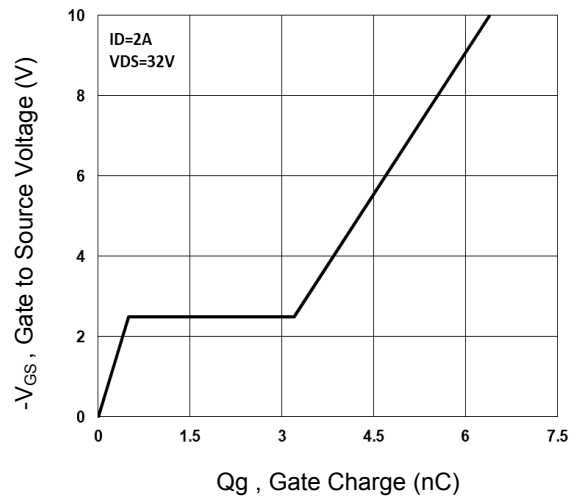
**Figure 1. Continuous Drain Current vs.  $T_J$**



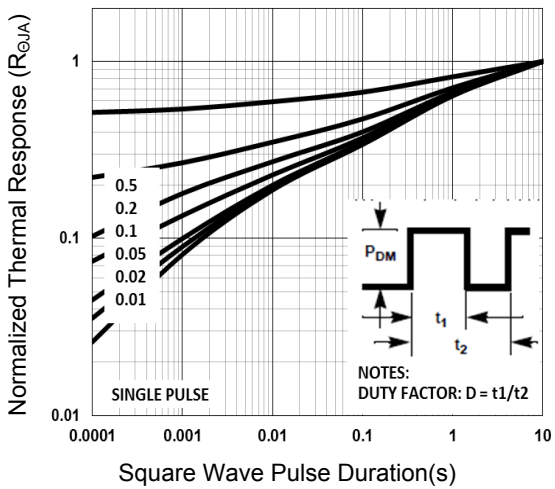
**Figure 2. Normalized  $R_{DS(ON)}$  vs.  $T_J$**



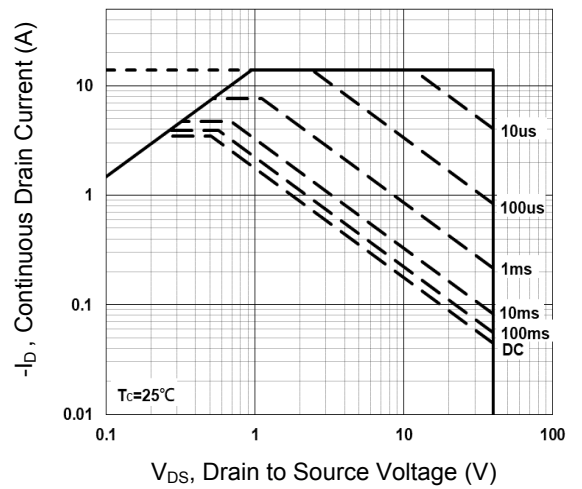
**Figure 3. Normalized  $V_{th}$  vs.  $T_J$**



**Figure 4. Gate Charge Characteristics**

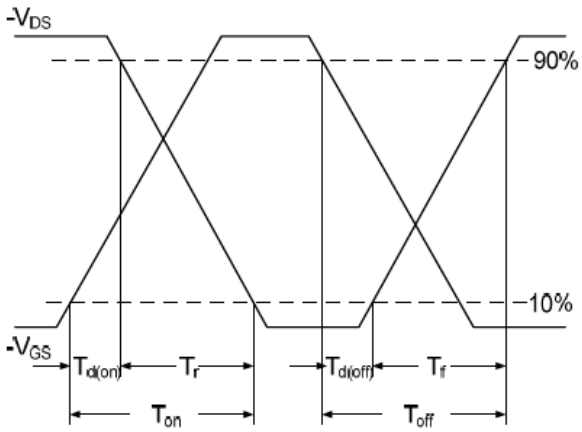


**Figure 5. Normalized Transient Impedance**

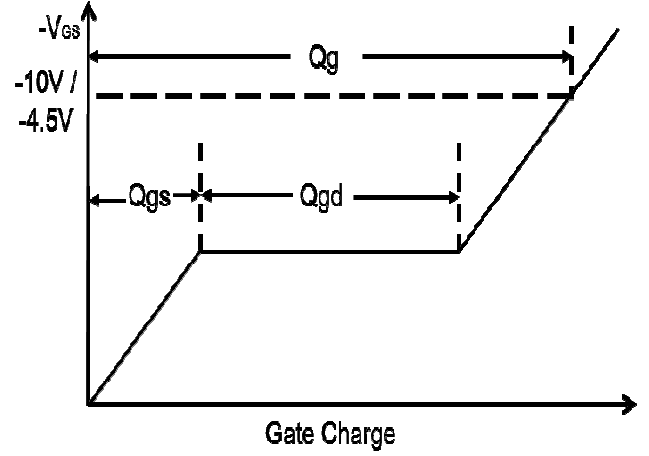


**Figure 6. Maximum Safe Operation Area**

**Typical Electrical and Thermal Characteristic Curves**

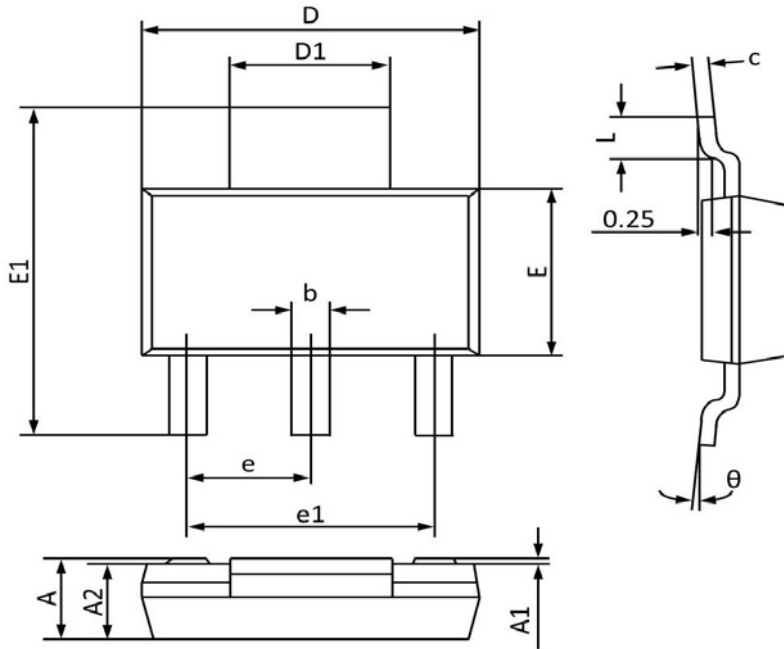


**Figure 7. Switching Time Waveform**



**Figure 8. Gate Charge Waveform**

**Package Outline Dimensions (SOT-223)**



Symbol	Dimensions In Millimeters		Dimensions In Inches	
	MAX	MIN	MAX	MIN
A	1.800	1.520	0.071	0.060
A1	0.100	0.000	0.004	0.000
A2	1.700	1.500	0.067	0.059
b	0.820	0.660	0.032	0.026
c	0.350	0.250	0.014	0.010
D	6.400	6.200	0.252	0.244
D1	3.100	2.900	0.122	0.114
E	3.700	3.300	0.146	0.130
E1	7.070	6.830	0.278	0.269
e	2.30(BSC)		0.091(BSC)	
e1	4.700	4.500	0.185	0.177
L	1.150	0.900	0.045	0.035
θ	10°	0°	10°	0°