

Main Product Characteristics

BV_{DSS}	30V
$R_{DS(ON)}$	40m Ω
I_D	2.1A

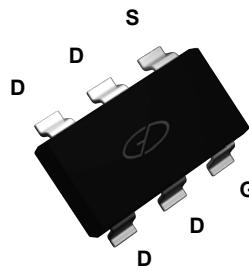

SOT-363

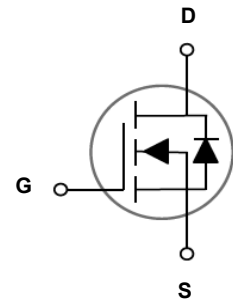

Schematic Diagram

Features and Benefits

- Advanced MOSFET process technology
- Ideal for high efficiency switched mode power supplies
- Low on-resistance with low gate charge
- Fast switching and reverse body recovery



Description

The GSFK0304 utilizes the latest techniques to achieve high cell density and low on-resistance. These features make this device extremely efficient and reliable for use in high efficiency switch mode power supply and a wide variety of other applications.

Absolute Maximum Ratings (T_C=25°C unless otherwise specified)

Parameter	Symbol	Max.	Unit
Drain-Source Voltage	V_{DS}	30	V
Gate-Source Voltage	V_{GS}	± 20	V
Drain Current-Continuous (T _A =25°C)	I_D	2.1	A
Drain Current-Continuous (T _A =70°C)		1.68	
Drain Current-Pulsed ¹	I_{DM}	8.4	A
Power Dissipation (T _A =25°C)	P_D	278	mW
Power Dissipation-De-rate above 25°C		2.22	mW/°C
Thermal Resistance, Junction-to-Ambient	$R_{\theta JA}$	450	°C/W
Operating Junction Temperature Range	T_J	-50 To +150	°C
Storage Temperature Range	T_{STG}	-50 To +150	°C

Electrical Characteristics ($T_J=25^{\circ}\text{C}$ unless otherwise specified)

Parameter	Symbol	Conditions	Min.	Typ.	Max.	Unit
On/Off Characteristics						
Drain-Source Breakdown Voltage	BV_{DSS}	$V_{GS}=0V, I_D=250\mu A$	30	-	-	V
BV_{DSS} Temperature Coefficient	$\Delta BV_{DSS}/\Delta T_J$	Reference to 25°C , $I_D=1mA$	-	0.018	-	$V/^{\circ}\text{C}$
Drain-Source Leakage Current	I_{DSS}	$V_{DS}=30V, V_{GS}=0V,$ $T_J=25^{\circ}\text{C}$	-	-	1	μA
		$V_{DS}=24V, V_{GS}=0V,$ $T_J=125^{\circ}\text{C}$	-	-	10	μA
Gate-Source Leakage Current	I_{GSS}	$V_{GS}=\pm 20V, V_{DS}=0V$	-	-	± 100	nA
Static Drain-Source On-Resistance	$R_{DS(ON)}$	$V_{GS}=10V, I_D=1.5A$	-	38	40	m Ω
		$V_{GS}=4.5V, I_D=1A$	-	51	66	
Gate Threshold Voltage	$V_{GS(th)}$	$V_{GS}=V_{DS}, I_D=250\mu A$	1	1.5	2.2	V
$V_{GS(th)}$ Temperature Coefficient	$\Delta V_{GS(th)}$		-	-3.2	-	mV/ $^{\circ}\text{C}$
Forward Transconductance	g_{fs}	$V_{DS}=10V, I_D=1.5A$	-	2.3	-	S
Dynamic and Switching Characteristics						
Total Gate Charge ^{2,3}	Q_g	$V_{DS}=24V, I_D=1A,$ $V_{GS}=10V$	-	3.1	6.4	nC
Gate-Source Charge ^{2,3}	Q_{gs}		-	0.1	0.5	
Gate-Drain Charge ^{2,3}	Q_{gd}		-	1.7	3.4	
Turn-On Delay Time ^{2,3}	$t_{d(on)}$	$V_{DD}=24V, R_G=3.3\Omega,$ $V_{GS}=10V, I_D=1A$	-	2.2	4.5	nS
Rise Time ^{2,3}	t_r		-	6.9	13.8	
Turn-Off Delay Time ^{2,3}	$t_{d(off)}$		-	15.2	30.4	
Fall Time ^{2,3}	t_f		-	4.5	9	
Input Capacitance	C_{iss}	$V_{DS}=25V, V_{GS}=0V,$ $F=1MHz$	-	245	490	pF
Output Capacitance	C_{oss}		-	40	80	
Reverse Transfer Capacitance	C_{rss}		-	78	158	
Gate Resistance	R_g	$V_{GS}=0V, V_{DS}=0V,$ $F=1MHz$	-	0.9	1.8	Ω
Drain-Source Diode Characteristics and Maximum Ratings						
Continuous Source Current	I_S	$V_G=V_D=0V,$ Force Current	-	-	2.1	A
Pulsed Source Current	I_{SM}		-	-	4.2	A
Diode Forward Voltage	V_{SD}	$V_{GS}=0V, I_S=1A,$ $T_J=25^{\circ}\text{C}$	-	-	1	V

Note:

1. Repetitive rating: Pulsed width limited by maximum junction temperature.
2. Pulse test: pulse width $\leq 300\mu s$, duty cycle $\leq 2\%$.
3. Essentially independent of operation temperature.

Typical Electrical and Thermal Characteristic Curves

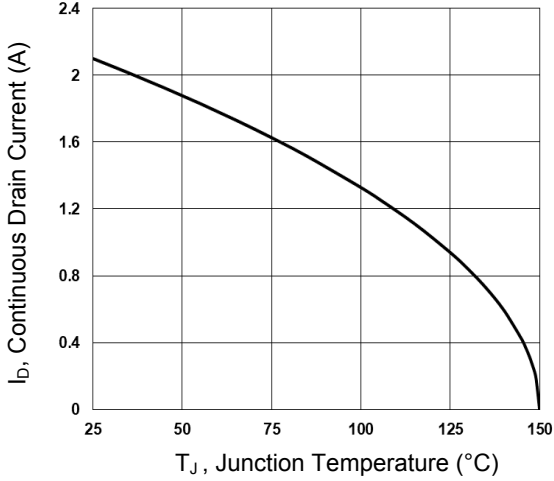

Figure 1. Continuous Drain Current vs. T_J

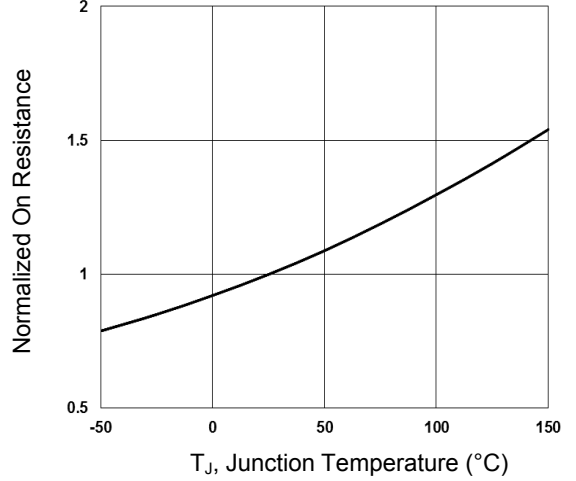

Figure 2. Normalized $R_{DS(ON)}$ vs. T_J

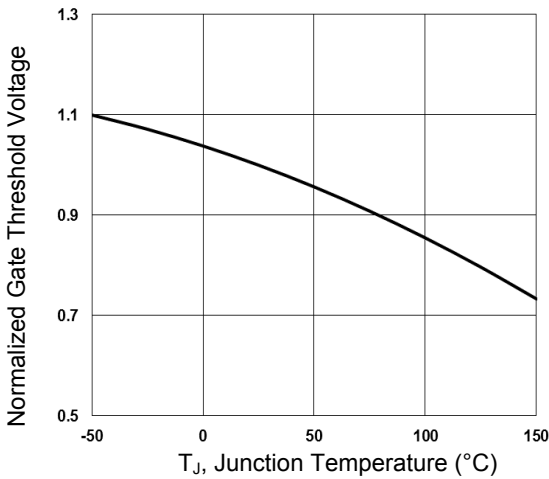

Figure 3. Normalized V_{th} vs. T_J

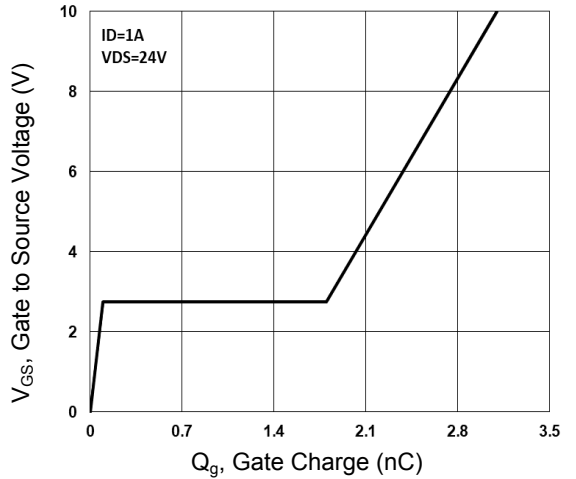

Figure 4. Gate Charge Waveform

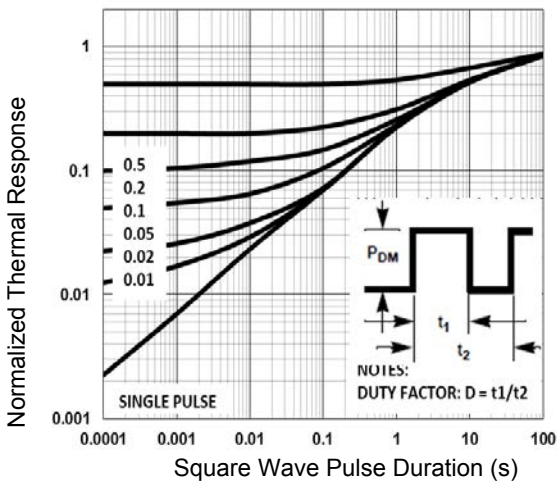

Figure 5. Normalized Transient Impedance

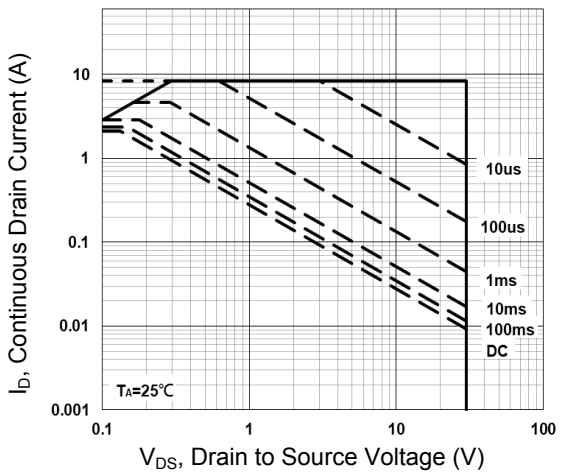

Figure 6. Maximum Safe Operation Area

Typical Electrical and Thermal Characteristic Curves

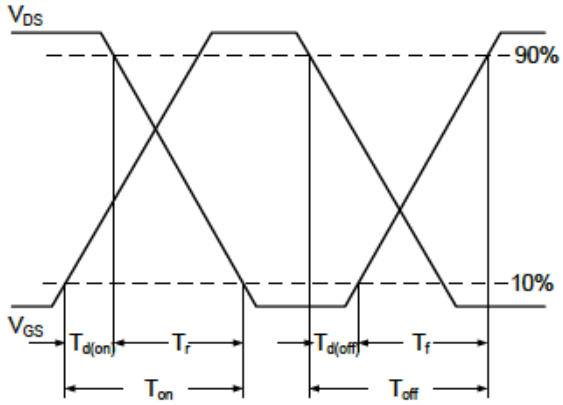

Figure 7. Switching Time Waveform

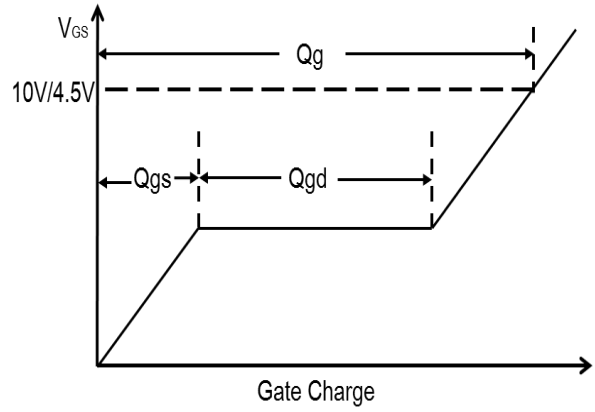
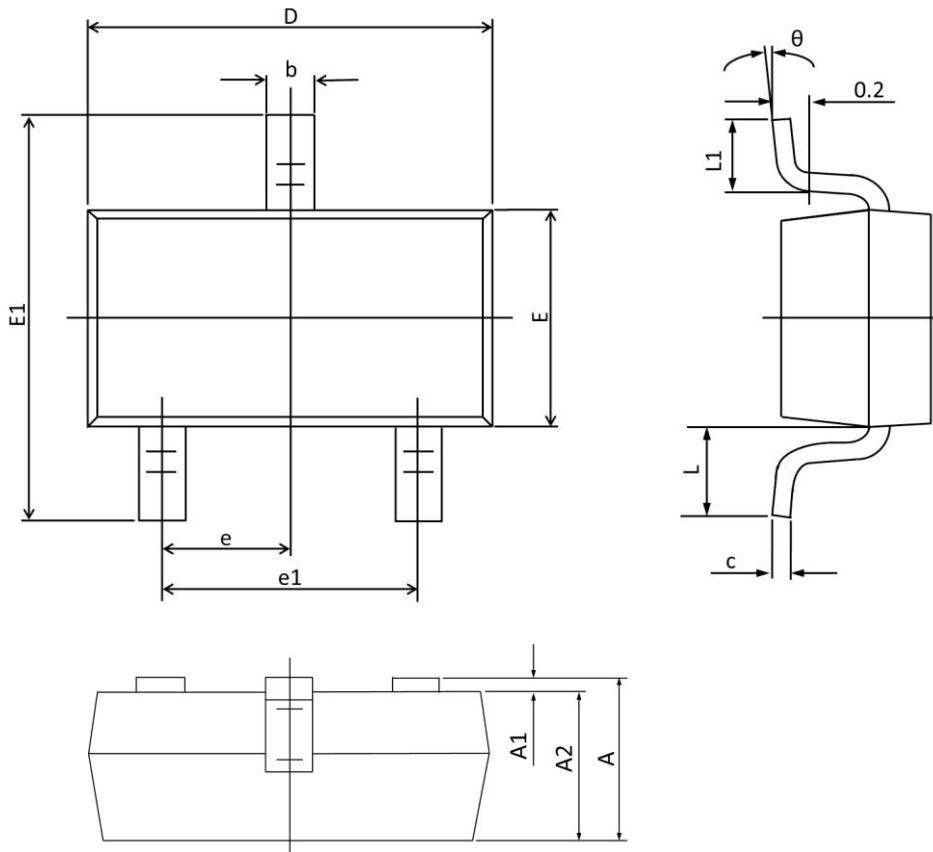

Figure 8. Gate Charge Waveform

Package Outline Dimensions (SOT-363)



Symbol	Dimensions In Millimeters		Dimensions In Inches	
	MAX	MIN	MAX	MIN
A	1.100	0.800	0.043	0.031
A1	0.100	0.000	0.004	0.000
A2	1.000	0.800	0.039	0.031
b	0.330	0.100	0.013	0.004
c	0.250	0.100	0.010	0.004
D	2.200	1.800	0.087	0.071
E	1.350	1.150	0.053	0.045
E1	2.400	1.800	0.094	0.071
e	0.65BSC		0.026BSC	
L1	0.350	0.100	0.014	0.004