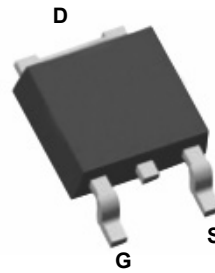
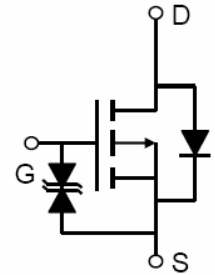


### Main Product Characteristics

$V_{DS}$	-100V
$R_{DS(ON)}$	100m $\Omega$
$I_D$	-18A



TO-252 (DPAK)



Schematic Diagram

### Features and Benefits

- Advanced MOSFET process technology
- Ideal for high efficiency switched mode power supplies
- Low on-resistance with low gate charge
- Fast switching and reverse body recovery



### Description

The GSFED1017 utilizes the latest techniques to achieve high cell density and low on-resistance. These features make this device extremely efficient and reliable for use in high efficiency switch mode power supply and a wide variety of other applications.

### Absolute Maximum Ratings (T<sub>C</sub>=25°C unless otherwise specified)

Parameter	Symbol	Max.	Unit
Drain-Source Voltage	$V_{DS}$	-100	V
Gate-Source Voltage	$V_{GS}$	±20	V
Drain Current-Continuous	$I_D$	-18	A
Drain Current-Continuous(T <sub>C</sub> =100°C)	$I_D(100^\circ C)$	-12	A
Pulsed Drain Current	$I_{DM}$	-100	A
Maximum Power Dissipation	$P_D$	70	W
Derating Factor		0.47	W/°C
Single Pulse Avalanche Energy <sup>5</sup>	$E_{AS}$	170	mJ
Thermal Resistance, Junction-to-Case <sup>2</sup>	$R_{\theta JC}$	2.14	°C/W
Operating Junction Temperature Range	$T_J$	-55 To +175	°C
Storage Temperature Range	$T_{STG}$	-55 To +175	°C

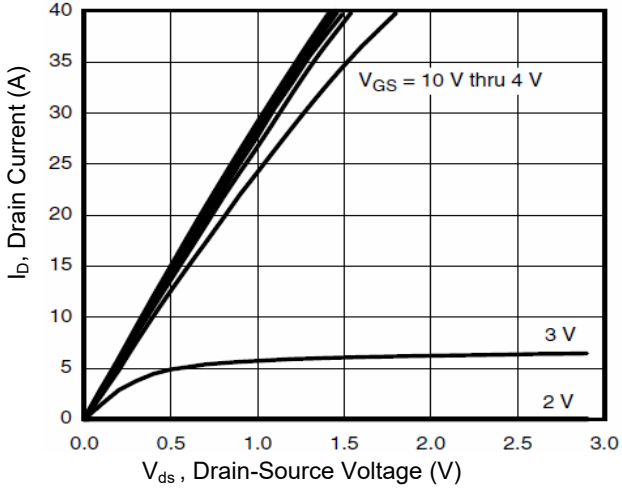
**Electrical Characteristics** ( $T_C=25^\circ\text{C}$  unless otherwise specified)

Parameter	Symbol	Conditions	Min.	Typ.	Max.	Unit
<b>Off Characteristics</b>						
Drain-Source Breakdown Voltage	$BV_{DSS}$	$V_{GS}=0V, I_D=-250\mu A$	-100	-	-	V
Zero Gate Voltage Drain Current	$I_{DSS}$	$V_{DS}=-100V, V_{GS}=0V$	-	-	-1	$\mu A$
Gate-Body Leakage Current	$I_{GSS}$	$V_{GS}=\pm 20V, V_{DS}=0V$	-	-	$\pm 20$	$\mu A$
<b>On Characteristics<sup>3</sup></b>						
Gate Threshold Voltage	$V_{GS(th)}$	$V_{DS}=V_{GS}, I_D=-250\mu A$	-1	-1.9	-3	V
Drain-Source On-State Resistance	$R_{DS(on)}$	$V_{GS}=-10V, I_D=-16A$	-	85	100	m $\Omega$
		$V_{GS}=-4.5V, I_D=-16A$	-	95	120	m $\Omega$
Forward Transconductance	$g_{FS}$	$V_{DS}=-50V, I_D=-10A$	5	-	-	S
<b>Dynamic Characteristics<sup>4</sup></b>						
Input Capacitance	$C_{iss}$	$V_{DS}=-50V, V_{GS}=0V, F=1.0MHz$	-	3810	-	PF
Output Capacitance	$C_{oss}$		-	129	-	PF
Reverse Transfer Capacitance	$C_{rss}$		-	125	-	PF
<b>Switching Characteristics<sup>4</sup></b>						
Turn-On Delay Time	$t_{d(on)}$	$V_{DD}=-50V, I_D=-16A, V_{GS}=-10V, R_{GEN}=9.1\Omega$	-	16	-	nS
Turn-On Rise Time	$t_r$		-	73	-	nS
Turn-Off Delay Time	$t_{d(off)}$		-	34	-	nS
Turn-Off Fall Time	$t_f$		-	57	-	nS
Total Gate Charge	$Q_g$	$V_{DS}=-50V, I_D=-16A, V_{GS}=-10V$	-	70	-	nC
Gate-Source Charge	$Q_{gs}$		-	12.5	-	nC
Gate-Drain Charge	$Q_{gd}$		-	15.5	-	nC
<b>Drain-Source Diode Characteristics</b>						
Diode Forward Voltage <sup>3</sup>	$V_{SD}$	$V_{GS}=0V, I_S=-10A$	-	-	-1.2	V
Diode Forward Current <sup>2</sup>	$I_S$	-	-	-	-18	A
Reverse Recovery Time	$t_{rr}$	$T_J=25^\circ\text{C}, I_F=-16A, di/dt=100A/\mu s^3$	-	88.3	-	nS
Reverse Recovery Charge	$Q_{rr}$		-	65.9	-	nC
Forward Turn-On Time	$t_{on}$	Intrinsic turn-on time is negligible(turn-on is dominated by LS+LD)				

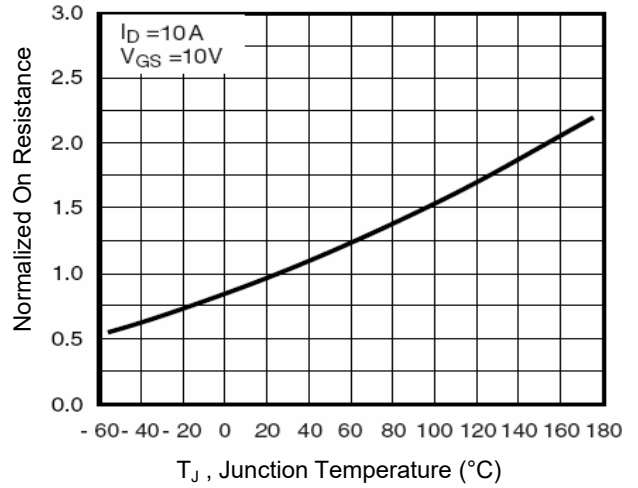
Notes:

1. Repetitive Rating: Pulse width limited by maximum junction temperature.
2. Surface Mounted on FR4 Board,  $t \leq 10$  sec.
3. Pulse Test: Pulse Width  $\leq 300\mu s$ , Duty Cycle  $\leq 2\%$ .
4. Guaranteed by design, not subject to production
5.  $E_{AS}$  condition:  $T_J=25^\circ\text{C}, V_{DD}=-50V, V_G=-10V, L=0.5mH, R_g=25\Omega$

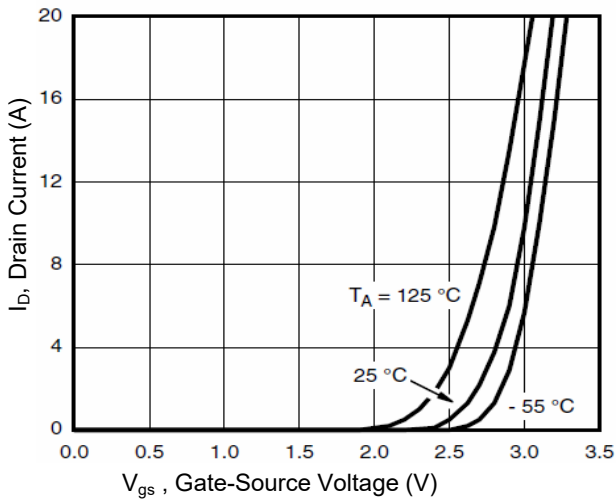
**Typical Electrical and Thermal Characteristic Curves**



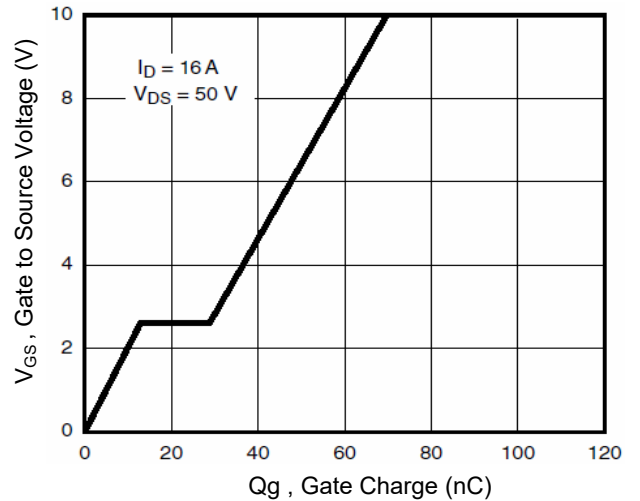
**Figure 1. Output Characteristics**



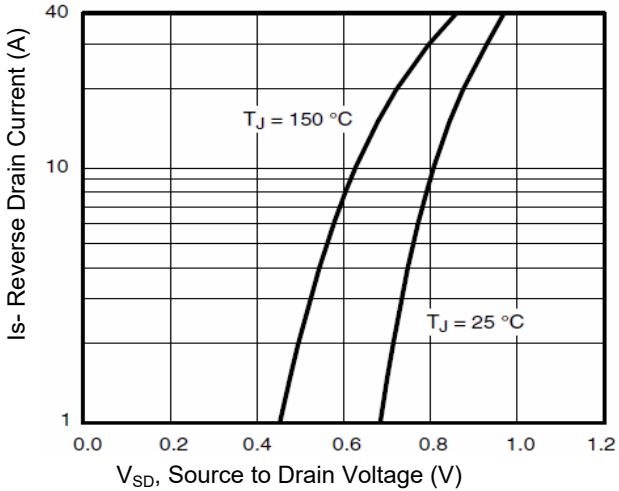
**Figure 2.  $R_{DS(ON)}$ -Junction Temperature**



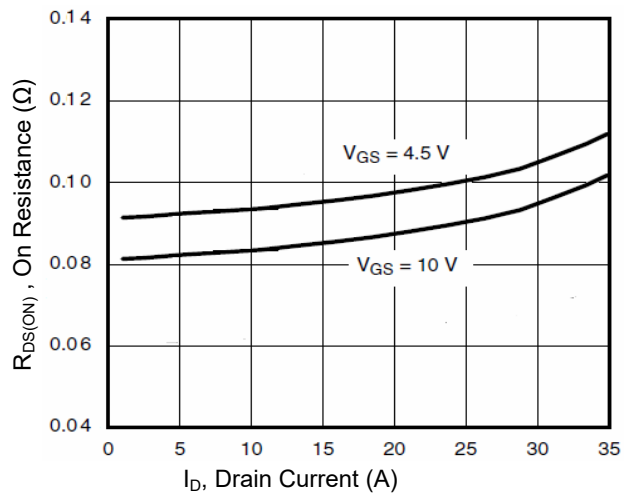
**Figure 3. Transfer Characteristics**



**Figure 4. Gate Charge**



**Figure 5. Source-Drain Diode Forward**



**Figure 6.  $R_{DS(ON)}$ -Drain Current**

## Typical Electrical and Thermal Characteristic Curves

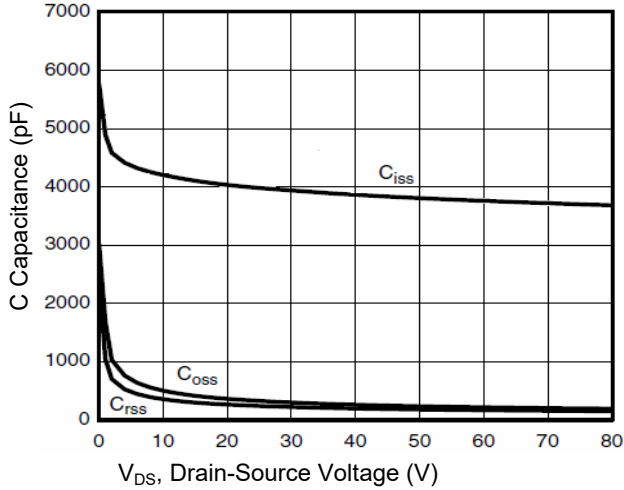


Figure 7. Capacitance vs.  $V_{DS}$

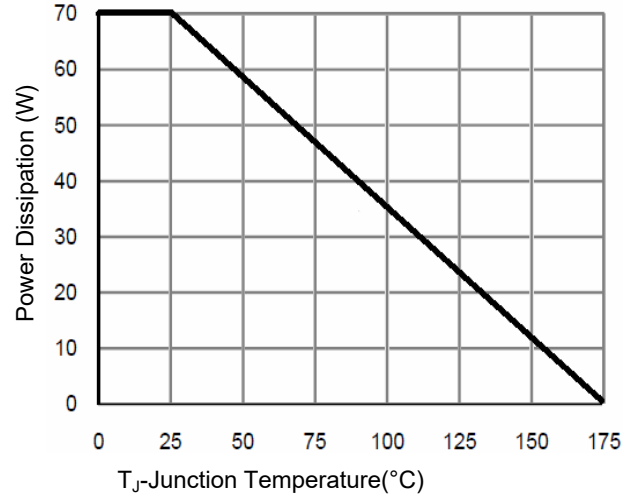


Figure 8. Power De-rating

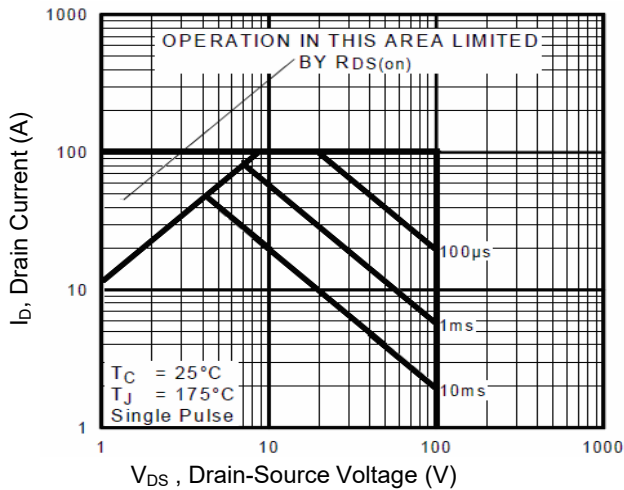


Figure 9. Safe Operation Area

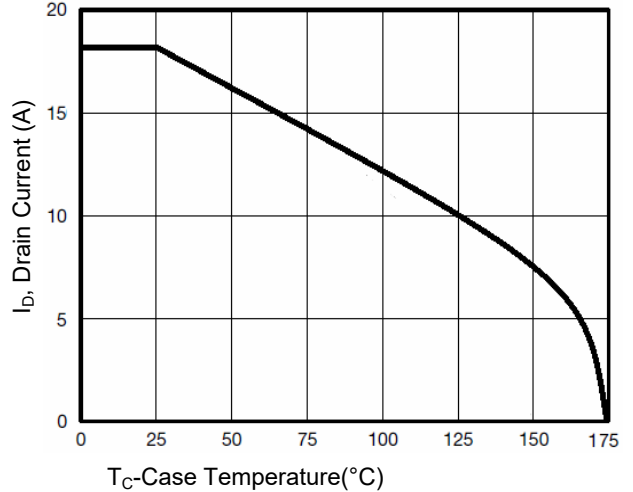


Figure 10. Drain Current vs. Case Temperature

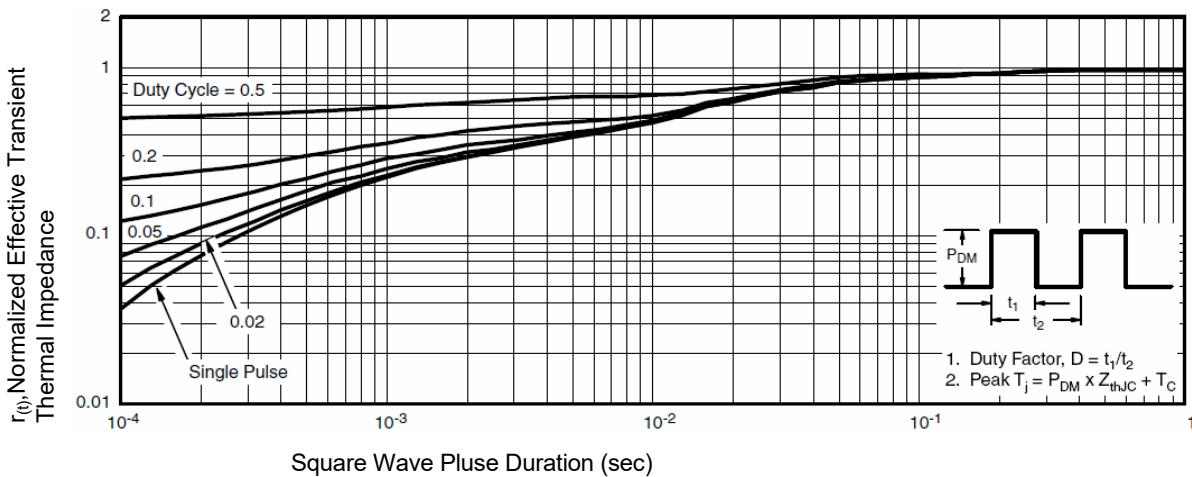
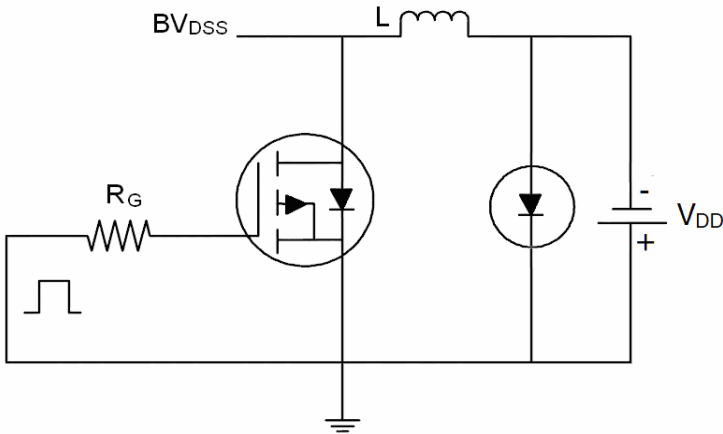
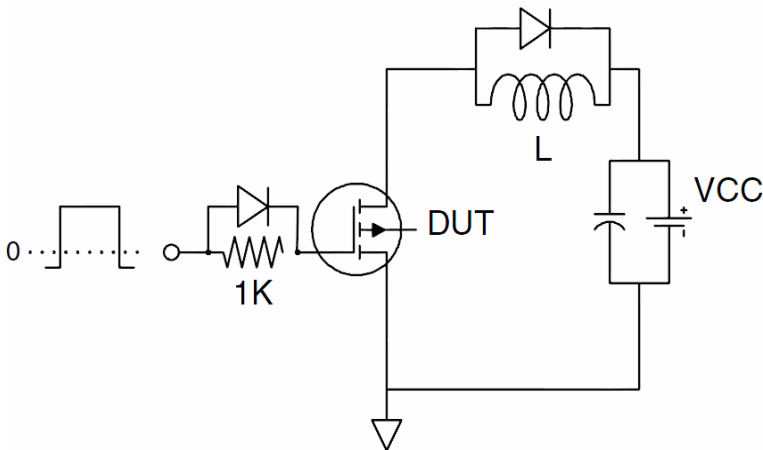


Figure 11. Normalized Maximum Transient Thermal Impedance

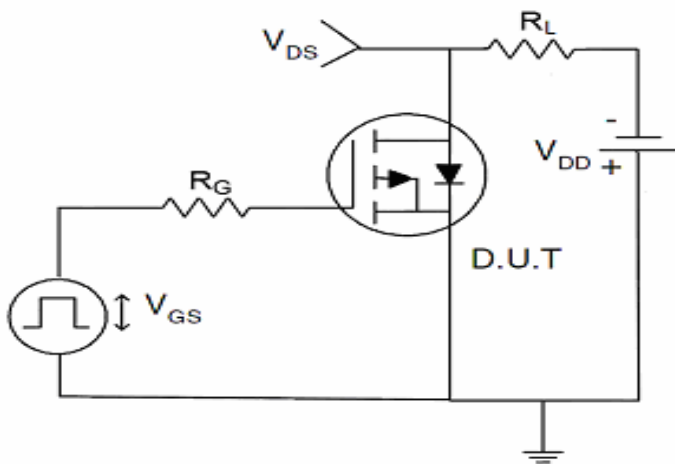
**Typical Electrical and Thermal Characteristic Curves**



**Figure 12. E<sub>AS</sub> Test Circuit**

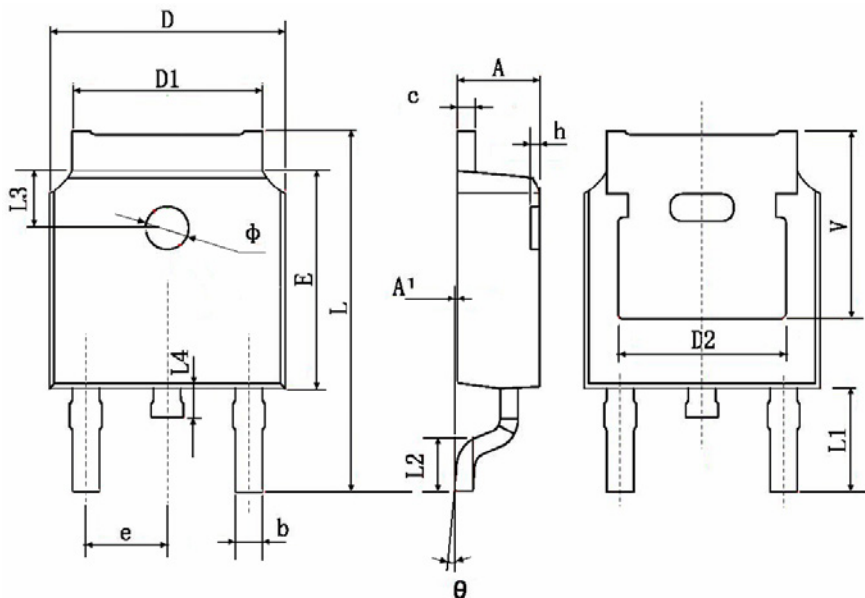


**Figure 13. Gate Charge Test Circuit**



**Figure 14. Switch Time Test Circuit**

## Package Outline Dimensions (TO-252/DPAK)



Symbol	Dimensions In Millimeters		Dimensions In Inches	
	Min.	Max.	Min.	Max.
A	2.200	2.400	0.087	0.094
A1	0.000	0.127	0.000	0.005
b	0.660	0.860	0.026	0.034
c	0.460	0.580	0.018	0.023
D	6.500	6.700	0.256	0.264
D1	5.100	5.460	0.201	0.215
D2	4.830 TYP.		0.190 TYP.	
E	6.000	6.200	0.236	0.244
e	2.186	2.386	0.086	0.094
L	9.800	10.400	0.386	0.409
L1	2.900 TYP.		0.114 TYP.	
L2	1.400	1.700	0.055	0.067
L3	1.600 TYP.		0.063 TYP.	
L4	0.600	1.000	0.024	0.039
Φ	1.100	1.300	0.043	0.051
θ	0°	8°	0°	8°
h	0.000	0.300	0.000	0.012
V	5.350 TYP.		0.211 TYP.	