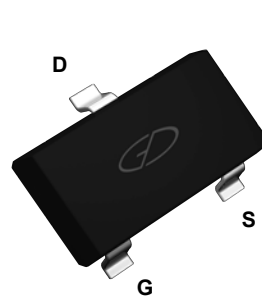
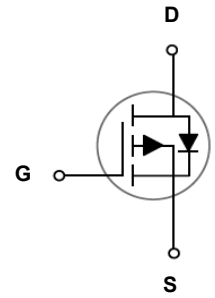


### Main Product Characteristics

$BV_{DSS}$	-30V
$R_{DS(ON)}$	65m $\Omega$
$I_D$	-4.1A



SOT-23



Schematic Diagram

### Features and Benefits

- Advanced MOSFET process technology
- Ideal for high efficiency switched mode power supplies
- Low on-resistance with low gate charge
- Fast switching and reverse body recovery



### Description

The GSFC0301 utilizes the latest techniques to achieve high cell density and low on-resistance. These features make this device extremely efficient and reliable for use in high efficiency switch mode power supply and a wide variety of other applications.

### Absolute Maximum Ratings (T<sub>C</sub>=25°C unless otherwise specified)

Parameter	Symbol	Max.	Unit
Drain-Source Voltage	V <sub>DS</sub>	-30	V
Gate-Source Voltage	V <sub>GS</sub>	±12	V
Drain Current-Continuous (T <sub>C</sub> =25°C)	I <sub>D</sub>	-4.1	A
Drain Current-Continuous (T <sub>C</sub> =100°C)		-2.6	
Drain Current-Pulsed <sup>1</sup>	I <sub>DM</sub>	-16.4	A
Power Dissipation (T <sub>C</sub> =25°C)	P <sub>D</sub>	1.56	W
Power Dissipation-Derate above 25°C		0.012	
Thermal Resistance, Junction-to-Ambient	R <sub>θJA</sub>	80	°C/W
Operating Junction Temperature Range	T <sub>J</sub>	-55 To +150	°C
Storage Temperature Range	T <sub>STG</sub>	-55 To +150	°C

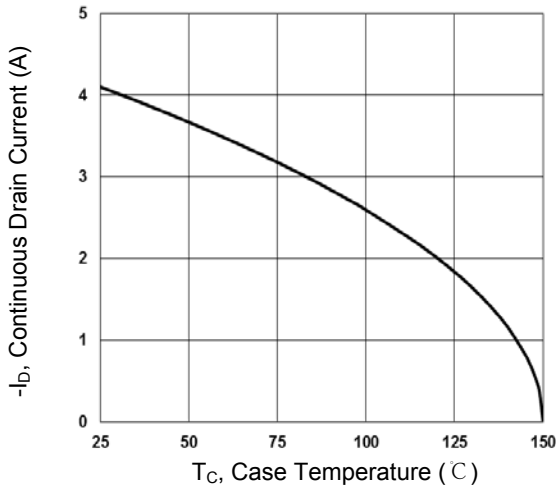
**Electrical Characteristics** ( $T_J=25^{\circ}\text{C}$  unless otherwise specified)

Parameter	Symbol	Conditions	Min.	Typ.	Max.	Unit
<b>On/Off Characteristics</b>						
Drain-Source Breakdown Voltage	$BV_{DSS}$	$V_{GS}=0V, I_D=-250\mu A$	-30	-	-	V
$BV_{DSS}$ Temperature Coefficient	$\Delta BV_{DSS}/\Delta T_J$	Reference to $25^{\circ}\text{C}$ , $I_D=-1mA$	-	-0.03	-	$V/^{\circ}\text{C}$
Drain-Source Leakage Current	$I_{DSS}$	$V_{DS}=-24V, V_{GS}=0V,$ $T_J=25^{\circ}\text{C}$	-	-	-1	$\mu A$
		$V_{DS}=-20V, V_{GS}=0V,$ $T_J=125^{\circ}\text{C}$	-	-	-10	$\mu A$
Gate-Source Leakage Current	$I_{GSS}$	$V_{GS}=\pm 12V, V_{DS}=0V$	-	-	$\pm 100$	nA
Static Drain-Source On-Resistance	$R_{DS(ON)}$	$V_{GS}=-10V, I_D=-4A$	-	55	65	m $\Omega$
		$V_{GS}=-4.5V, I_D=-3A$	-	65	75	
		$V_{GS}=-2.5V, I_D=-2A$	-	85	100	
Gate Threshold Voltage	$V_{GS(th)}$	$V_{GS}=V_{DS}, I_D=-250\mu A$	-0.4	-0.7	-0.9	V
$V_{GS(th)}$ Temperature Coefficient	$\Delta V_{GS(th)}$		-	3	-	mV/ $^{\circ}\text{C}$
Forward Transconductance	$g_{fs}$	$V_{DS}=-10V, I_D=-3A$	-	5.4	-	S
<b>Dynamic and Switching Characteristics</b>						
Total Gate Charge <sup>2,3</sup>	$Q_g$	$V_{DS}=-15V, I_D=-4A,$ $V_{GS}=-4.5V$	-	8	11	nC
Gate-Source Charge <sup>2,3</sup>	$Q_{gs}$		-	1.9	3	
Gate-Drain Charge <sup>2,3</sup>	$Q_{gd}$		-	1.4	3	
Turn-On Delay Time <sup>2,3</sup>	$t_{d(on)}$	$V_{DD}=-15V, R_G=6\Omega,$ $V_{GS}=-10V, I_D=-1A$	-	5.4	10	nS
Rise Time <sup>2,3</sup>	$t_r$		-	19.4	37	
Turn-Off Delay Time <sup>2,3</sup>	$t_{d(off)}$		-	45.9	87	
Fall Time <sup>2,3</sup>	$t_f$		-	12.4	24	
Input Capacitance	$C_{iss}$	$V_{DS}=-15V, V_{GS}=0V,$ $F=1MHz$	-	810	1175	pF
Output Capacitance	$C_{oss}$		-	85	125	
Reverse Transfer Capacitance	$C_{rss}$		-	50	75	
<b>Drain-Source Diode Characteristics and Maximum Ratings</b>						
Continuous Source Current	$I_S$	$V_G=V_D=0V,$ Force Current	-	-	-4.1	A
Pulsed Source Current	$I_{SM}$		-	-	-16.4	A
Diode Forward Voltage	$V_{SD}$	$V_{GS}=0V, I_S=-1A,$ $T_J=25^{\circ}\text{C}$	-	-	-1	V

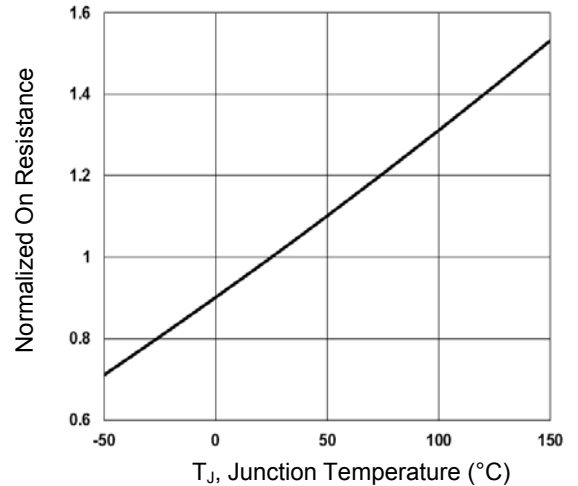
Note:

1. Repetitive rating: Pulsed width limited by maximum junction temperature.
2. Pulse test: pulse width  $\leq 300\mu s$ , duty cycle  $\leq 2\%$ .
3. Essentially independent of operation temperature.

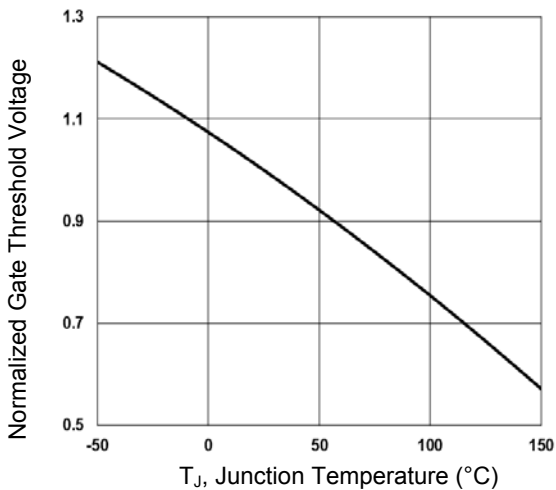
**Typical Electrical and Thermal Characteristic Curves**



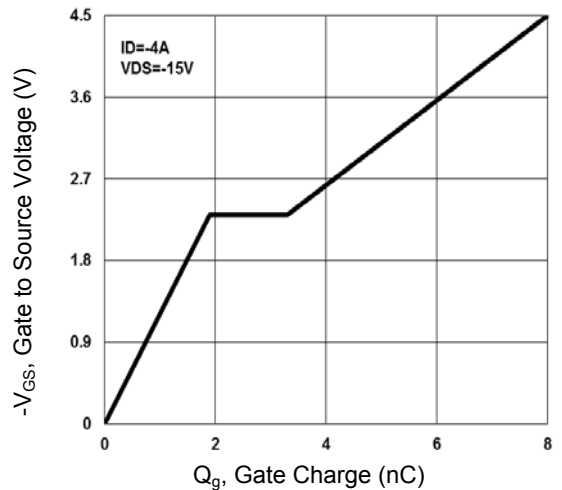
**Figure 1. Continuous Drain Current vs.  $T_c$**



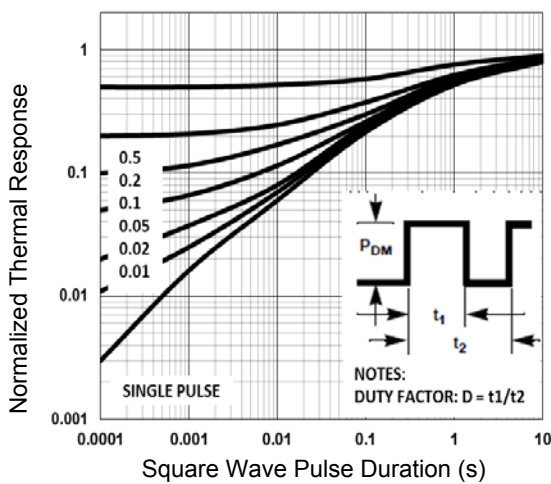
**Figure 2. Normalized  $R_{DSON}$  vs.  $T_j$**



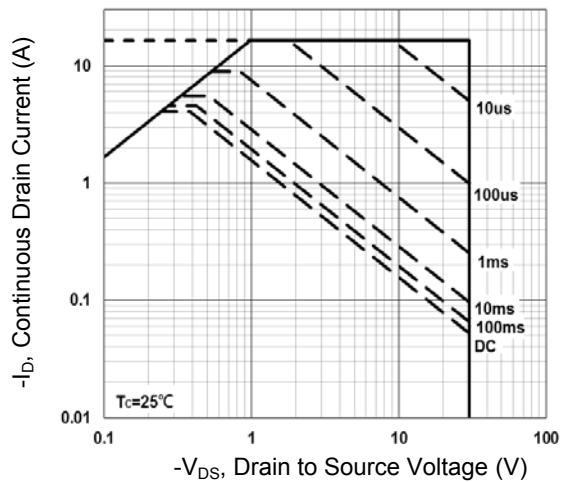
**Figure 3. Normalized  $V_{th}$  vs.  $T_j$**



**Figure 4. Gate Charge Waveform**

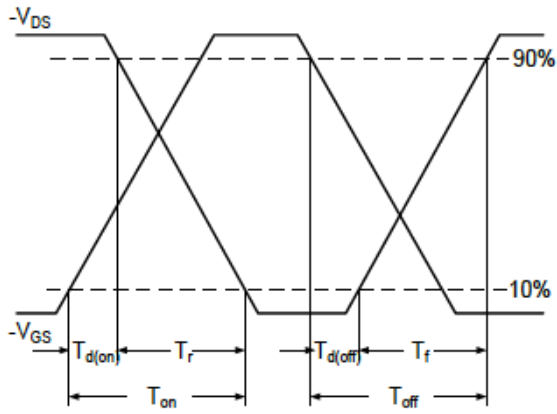


**Figure 5. Normalized Transient Impedance**

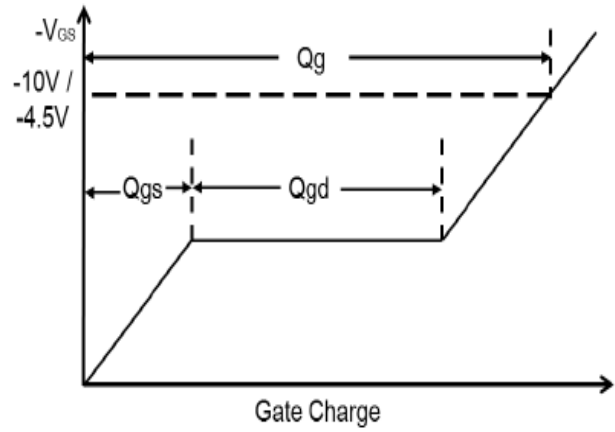


**Figure 6. Maximum Safe Operation Area**

**Typical Electrical and Thermal Characteristic Curves**

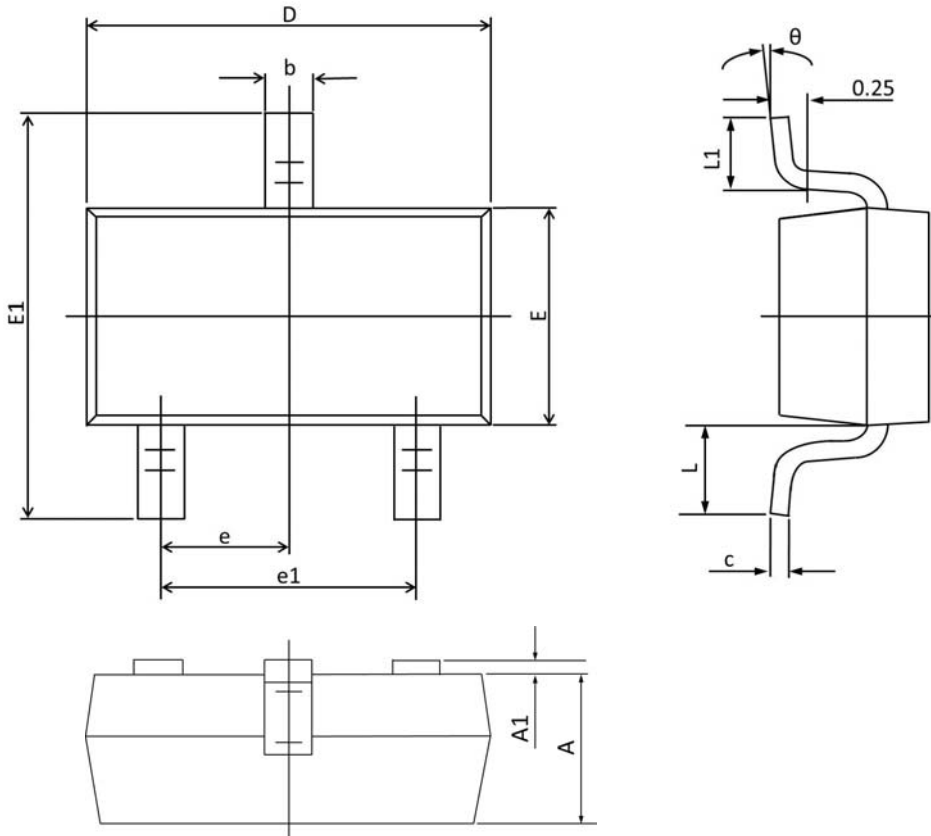


**Figure 7. Switching Time Waveform**



**Figure 8. Gate Charge Waveform**

**Package Outline Dimensions (SOT-23)**



Symbol	Dimensions In Millimeters		Dimensions In Inches	
	Min	Max	Min	Max
A	0.900	1.000	0.035	0.039
A1	0.000	0.100	0.000	0.004
b	0.300	0.500	0.012	0.020
c	0.090	0.110	0.003	0.004
D	2.800	3.000	0.110	0.118
E	1.200	1.400	0.047	0.055
E1	2.250	2.550	0.089	0.100
e	0.950 TYP.		0.037 TYP.	
e1	1.800	2.000	0.071	0.079
L	0.550 REF.		0.022 REF.	
L1	0.300	0.5	0.012	0.020
θ	1°	7°	1°	7°