

Main Product Characteristics

BV_{DSS}	-25V
$R_{DS(ON)}$	640mΩ
I_D	-0.85A

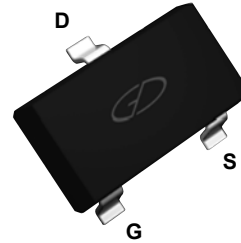

SOT-23

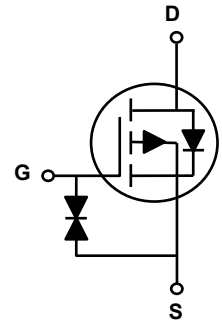

Schematic Diagram

Features and Benefits

- Advanced MOSFET process technology
- Ideal for high efficiency switched mode power supplies
- Low on-resistance with low gate charge
- Fast switching and reverse body recovery



Description

The GSFC02501 utilizes the latest techniques to achieve high cell density and low on-resistance. These features make this device extremely efficient and reliable for use in high efficiency switch mode power supplies and a wide variety of other applications.

Absolute Maximum Ratings ($T_J=25^{\circ}\text{C}$ unless otherwise specified)

Parameter	Symbol	Max.	Unit
Drain-Source Voltage	V_{DS}	-25	V
Gate-Source Voltage	V_{GS}	± 8	V
Drain Current-Continuous ($T_A=25^{\circ}\text{C}$) ^{1,3}	I_D	-0.85	A
Drain Current-Continuous ($T_A=70^{\circ}\text{C}$) ^{1,3}		-0.68	
Drain Current-Pulsed ²	I_{DM}	-2.1	A
Power Dissipation ($T_A=25^{\circ}\text{C}$)	P_D	0.69	W
Power Dissipation ($T_A=70^{\circ}\text{C}$)		0.44	
Thermal Resistance, Junction-to-Ambient ¹	$R_{\theta JA}$	180	$^{\circ}\text{C/W}$
Operating Junction Temperature Range	T_J	-55 To +150	$^{\circ}\text{C}$
Storage Temperature Range	T_{STG}	-55 To +150	$^{\circ}\text{C}$

Electrical Characteristics ($T_J=25^\circ\text{C}$ unless otherwise specified)

Parameter	Symbol	Conditions	Min.	Typ.	Max.	Unit
On / Off Characteristics						
Drain-Source Breakdown Voltage	BV_{DSS}	$V_{GS}=0V, I_D=-250\mu A$	-25	-	-	V
Drain-Source Leakage Current	I_{DSS}	$V_{DS}=-16V, V_{GS}=0V$	-	-	-1	μA
Gate-Source Leakage Current	I_{GSS}	$V_{GS}=\pm 12V, V_{DS}=0V$	-	-	± 10	μA
Static Drain-Source On-Resistance	$R_{DS(ON)}$	$V_{GS}=-4.5V, I_D=-0.55A$	-	530	640	m Ω
		$V_{GS}=-2.5V, I_D=-0.45A$	-	730	950	
		$V_{GS}=-1.8V, I_D=-0.35A$	-	1300	1950	
Gate Threshold Voltage	$V_{GS(th)}$	$V_{GS}=V_{DS}, I_D=-250\mu A$	-0.5	-	-1	V
Forward Transconductance	g_{fs}	$V_{DS}=-5V, I_D=-0.55A$	-	1	-	S
Dynamic and Switching Characteristics						
Total Gate Charge ^{3,4}	Q_g	$V_{GS}=-2.5V, V_{DS}=-10V, I_D=-1A$	-	0.53	-	nC
Total Gate Charge ^{3,4}	Q_g	$V_{DS}=-10V, I_D=-1A, V_{GS}=-4.5V$	-	0.8	-	nC
Gate-Source Charge ^{3,4}	Q_{gs}		-	0.2	-	
Gate-Drain Charge ^{3,4}	Q_{gd}		-	0.2	-	
Turn-On Delay Time ^{3,4}	$t_{d(on)}$	$V_{DS}=-10V, R_G=3\Omega, V_{GS}=-4.5V, I_D=-1.33A$	-	400	-	nS
Rise Time ^{3,4}	t_r		-	60	-	
Turn-Off Delay Time ^{3,4}	$t_{d(off)}$		-	20	-	
Fall Time ^{3,4}	t_f		-	800	-	
Input Capacitance	C_{iss}	$V_{DS}=-10V, V_{GS}=0V, F=1MHz$	-	58	-	pF
Output Capacitance	C_{oss}		-	5.7	-	
Reverse Transfer Capacitance	C_{rss}		-	4.4	-	
Drain-Source Diode Characteristics and Maximum Ratings						
Diode Forward Voltage	V_{SD}	$V_{GS}=0V, I_{SD}=-1A$	-	-	-1.1	V
Reverse Recovery Time	t_{rr}	$I_F=-1A,$	-	9.2	-	nS
Reverse Recovery Charge	Q_{rr}	$di/dt=100A/\mu s$	-	0.8	-	nC

Notes:

1. The value of $R_{\theta JA}$ is measured with the device mounted on 1in² FR-4 board with 2oz. Copper, in a still air environment with $T_A=25^\circ\text{C}$. The value in any given application depends on the user's specific board design.
2. Repetitive rating, pulse width limited by junction temperature.
3. The current rating is based on the $t < 10s$ junction to ambient thermal resistance rating.

Typical Electrical and Thermal Characteristic Curves

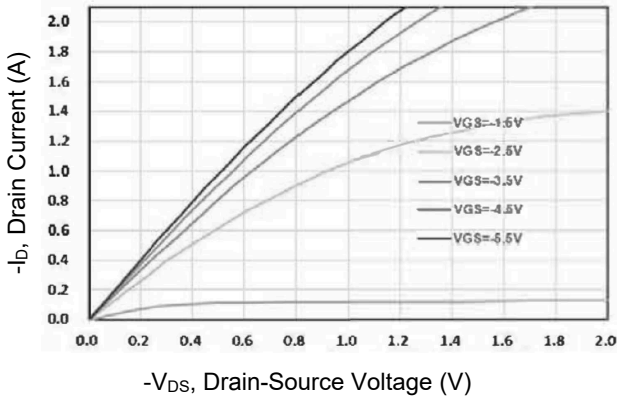

Figure 1. Output Characteristics

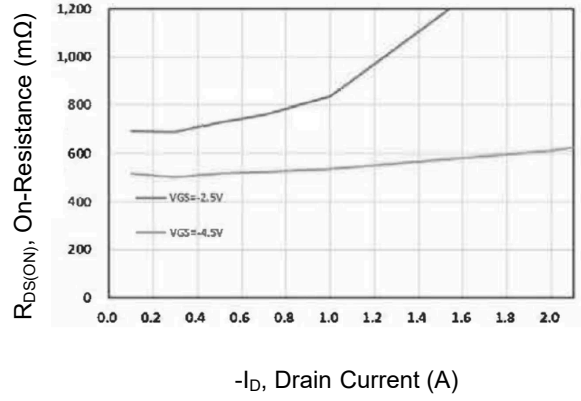

Figure 2. On-Resistance vs. I_D

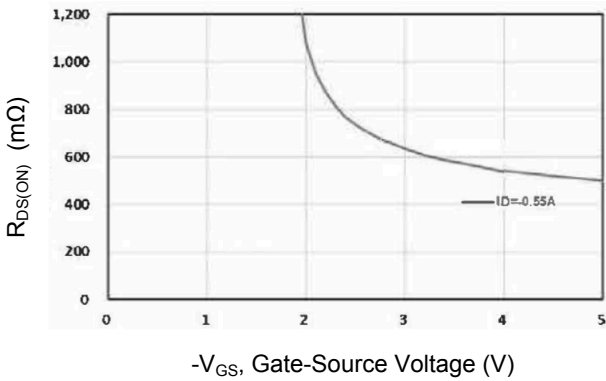

Figure 3. Power Dissipation

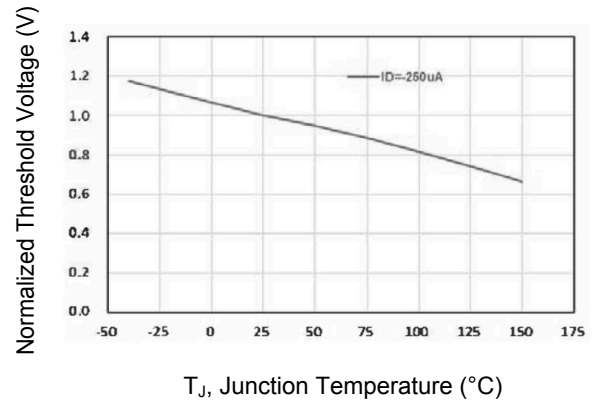

Figure 4. Gate Threshold Voltage

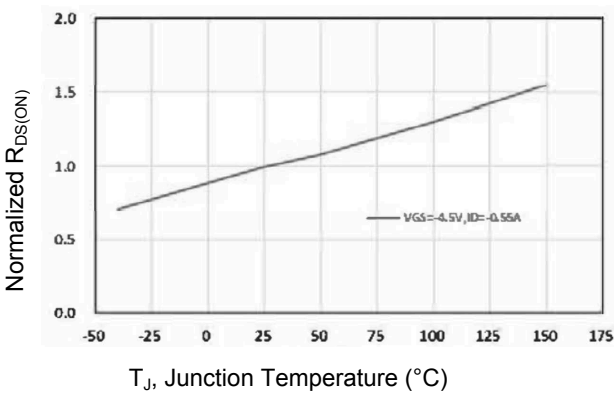

Figure 5. Drain-Source On Resistance

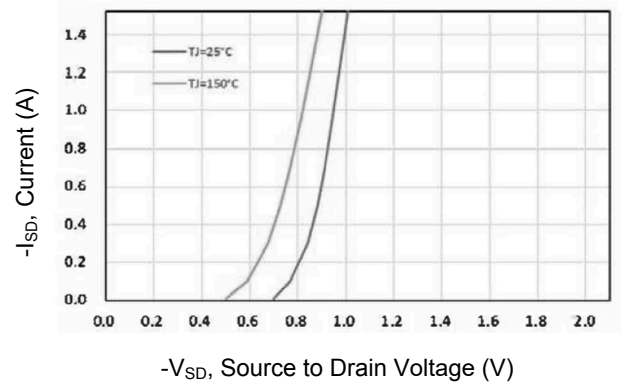

Figure 6. Source-Drain Diode Forward

Typical Electrical and Thermal Characteristic Curves

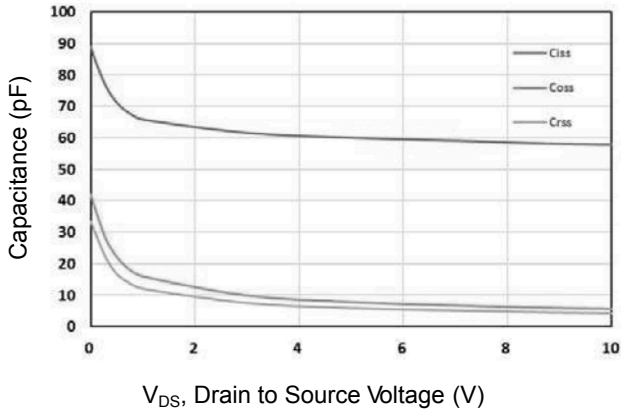

Figure 7. Capacitance Characteristics

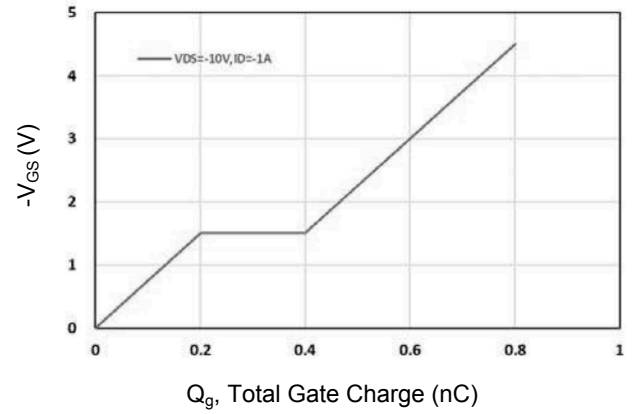

Figure 8. Gate Charge Characteristics

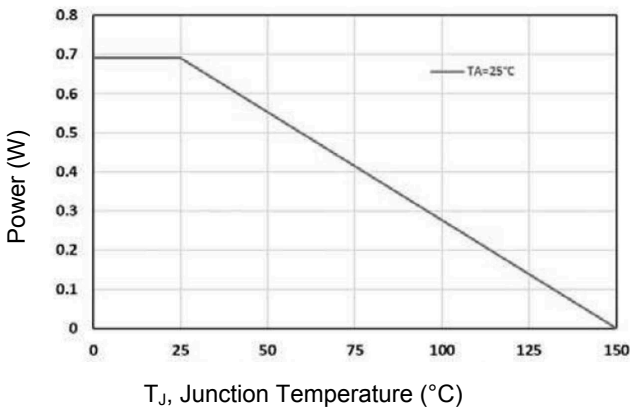

Figure 9. Power Dissipation

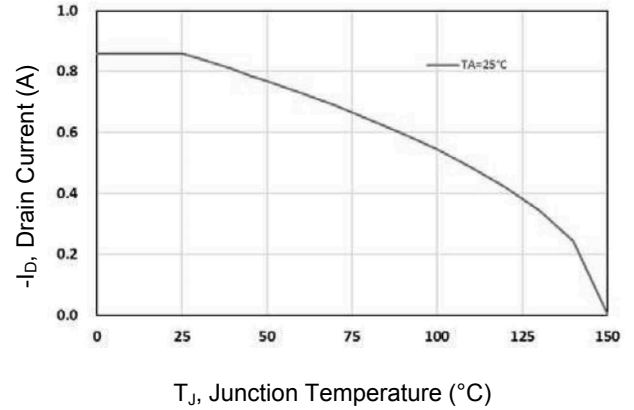

Figure 10. Drain Current

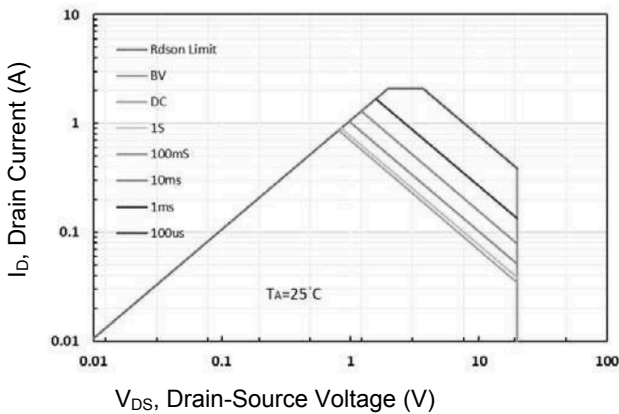

Figure 11. Safe Operating Area

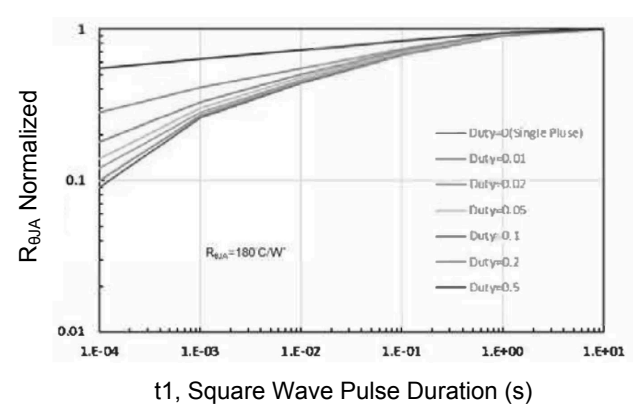
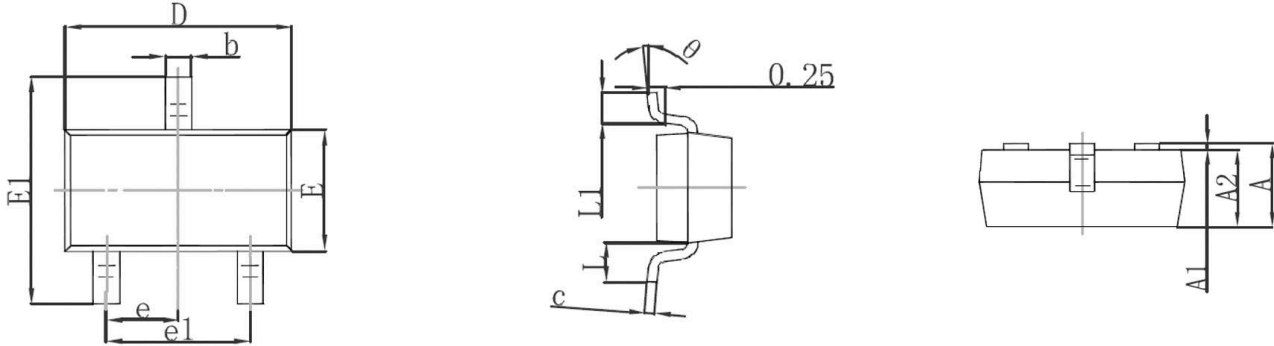

Figure 12. $R_{\theta JA}$ Transient Thermal Impedance

Package Outline Dimensions (SOT-23)



Symbol	Dimensions In Millimeters		Dimensions In Inches	
	Min	Max	Min	Max
A	0.900	1.150	0.035	0.045
A1	0.000	0.100	0.000	0.004
A2	0.900	1.050	0.035	0.041
b	0.200	0.500	0.008	0.020
c	0.080	0.150	0.003	0.006
D	2.800	3.000	0.110	0.118
E	1.150	1.400	0.045	0.055
E1	2.150	2.550	0.085	0.100
e	0.950 TYP		0.037 TYP	
e1	1.800	2.000	0.071	0.079
L	0.550 REF		0.022 REF	
L1	0.260	0.500	0.010	0.020
θ	0°	8°	0°	8°

Order Information

Device	Package	Marking	Carrier	Quantity
GSFC02501	SOT-23	1149	Tape & Reel	3,000pcs/reel