

Main Product Characteristics

| | |
|--------------|--------------|
| BV_{DSS} | 20V |
| $R_{DS(ON)}$ | 65m Ω |
| I_D | 4A |

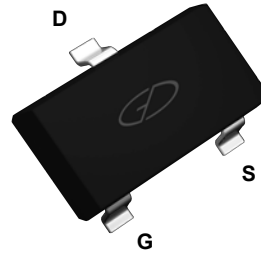

SOT-23

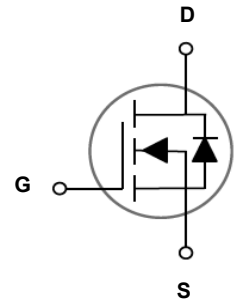

Schematic Diagram

Features and Benefits

- Advanced MOSFET process technology
- Ideal for high efficiency switched mode power supplies
- Low on-resistance with low gate charge
- Fast switching and reverse body recovery



Description

The GSFC0204 utilizes the latest techniques to achieve high cell density and low on-resistance. These features make this device extremely efficient and reliable for use in high efficiency switch mode power supply and a wide variety of other applications.

Absolute Maximum Ratings ($T_C=25^\circ\text{C}$ unless otherwise specified)

| Parameter | Symbol | Max. | Unit |
|--|-----------------|-------------|---------------------------|
| Drain-Source Voltage | V_{DS} | 20 | V |
| Gate-Source Voltage | V_{GS} | ± 10 | V |
| Drain Current-Continuous ($T_C=25^\circ\text{C}$) | I_D | 4 | A |
| Drain Current-Continuous ($T_C=100^\circ\text{C}$) | | 2.5 | |
| Drain Current-Pulsed ¹ | I_{DM} | 16 | A |
| Power Dissipation ($T_C=25^\circ\text{C}$) | P_D | 1.56 | W |
| Power Dissipation-Derate above 25°C | | 0.012 | |
| Thermal Resistance, Junction-to-Ambient | $R_{\theta JA}$ | 80 | $^\circ\text{C}/\text{W}$ |
| Operating Junction Temperature Range | T_J | -55 To +150 | $^\circ\text{C}$ |
| Storage Temperature Range | T_{STG} | -55 To +150 | $^\circ\text{C}$ |

Electrical Characteristics ($T_J=25^{\circ}\text{C}$ unless otherwise specified)

| Parameter | Symbol | Conditions | Min. | Typ. | Max. | Unit |
|---|------------------------------|---|------|------|-----------|------------------------|
| On/Off Characteristics | | | | | | |
| Drain-Source Breakdown Voltage | BV_{DSS} | $V_{GS}=0V, I_D=250\mu A$ | 20 | - | - | V |
| BV_{DSS} Temperature Coefficient | $\Delta BV_{DSS}/\Delta T_J$ | Reference to 25°C , $I_D=1mA$ | - | 0.02 | - | $V/^{\circ}\text{C}$ |
| Drain-Source Leakage Current | I_{DSS} | $V_{DS}=20V, V_{GS}=0V,$ $T_J=25^{\circ}\text{C}$ | - | - | 1 | μA |
| | | $V_{DS}=16V, V_{GS}=0V,$ $T_J=125^{\circ}\text{C}$ | - | - | 10 | μA |
| Gate-Source Leakage Current | I_{GSS} | $V_{GS}=\pm 10V, V_{DS}=0V$ | - | - | ± 100 | nA |
| Static Drain-Source On-Resistance | $R_{DS(ON)}$ | $V_{GS}=4.5V, I_D=3A$ | - | 50 | 65 | m Ω |
| | | $V_{GS}=2.5V, I_D=2A$ | - | 60 | 80 | |
| | | $V_{GS}=1.8V, I_D=1A$ | - | 85 | 120 | |
| Gate Threshold Voltage | $V_{GS(th)}$ | $V_{GS}=V_{DS}, I_D=250\mu A$ | 0.3 | 0.5 | 1 | V |
| $V_{GS(th)}$ Temperature Coefficient | $\Delta V_{GS(th)}$ | | - | 2 | - | mV/ $^{\circ}\text{C}$ |
| Forward Transconductance | g_{fs} | $V_{DS}=10V, I_S=2A$ | - | 4.4 | - | S |
| Dynamic and Switching Characteristics | | | | | | |
| Total Gate Charge ^{2,3} | Q_g | $V_{DS}=10V, I_D=1A,$ $V_{GS}=4.5V$ | - | 3.6 | 7.2 | nC |
| Gate-Source Charge ^{2,3} | Q_{gs} | | - | 0.38 | 0.76 | |
| Gate-Drain Charge ^{2,3} | Q_{gd} | | - | 0.6 | 1.2 | |
| Turn-On Delay Time ^{2,3} | $t_{d(on)}$ | $V_{DD}=10V, R_G=25\Omega,$ $V_{GS}=4.5V, I_D=1A$ | - | 1.8 | 5 | nS |
| Rise Time ^{2,3} | t_r | | - | 5.6 | 12 | |
| Turn-Off Delay Time ^{2,3} | $t_{d(off)}$ | | - | 11.3 | 24 | |
| Fall Time ^{2,3} | t_f | | - | 3.2 | 7 | |
| Input Capacitance | C_{iss} | $V_{DS}=15V, V_{GS}=0V,$ $F=1MHz$ | - | 180 | 360 | pF |
| Output Capacitance | C_{oss} | | - | 32 | 64 | |
| Reverse Transfer Capacitance | C_{rss} | | - | 26 | 52 | |
| Drain-Source Diode Characteristics and Maximum Ratings | | | | | | |
| Continuous Source Current | I_S | $V_G=V_D=0V,$ Force Current | - | - | 4 | A |
| Pulsed Source Current | I_{SM} | | - | - | 8 | A |
| Diode Forward Voltage | V_{SD} | $V_{GS}=0V, I_S=1A,$ $T_J=25^{\circ}\text{C}$ | - | - | 1 | V |

Note:

1. Repetitive rating: Pulsed width limited by maximum junction temperature.
2. Pulse test: pulse width $\leq 300\mu s$, duty cycle $\leq 2\%$.
3. Essentially independent of operating temperature.

Typical Electrical and Thermal Characteristic Curves

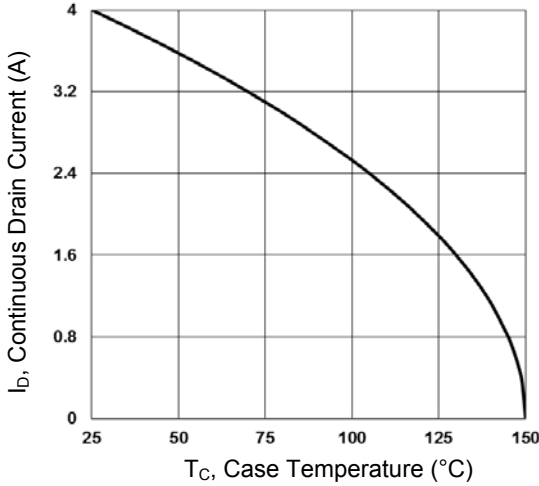

Figure 1. Continuous Drain Current vs. T_C

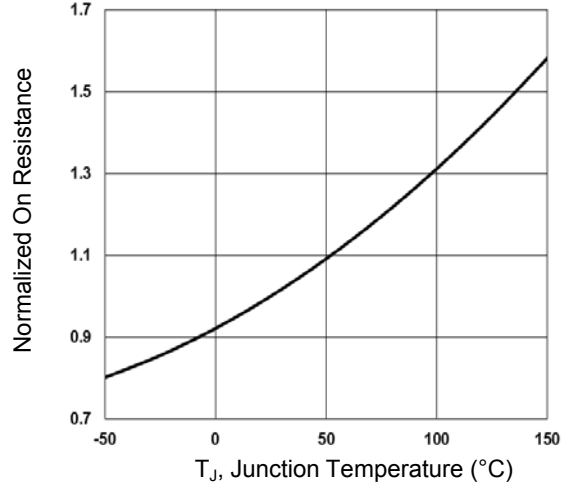

Figure 2. Normalized $R_{DS(ON)}$ vs. T_J

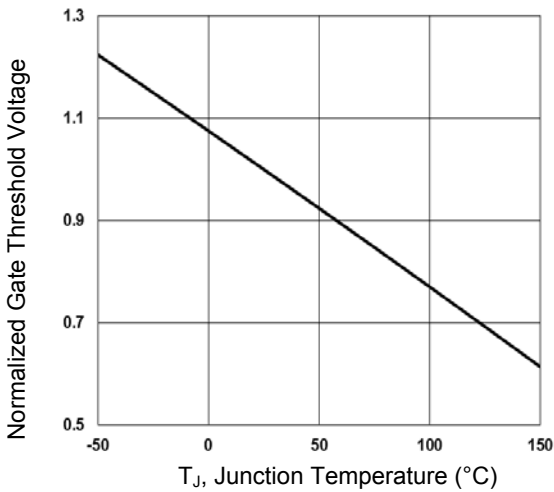

Figure 3. Normalized V_{th} vs. T_J

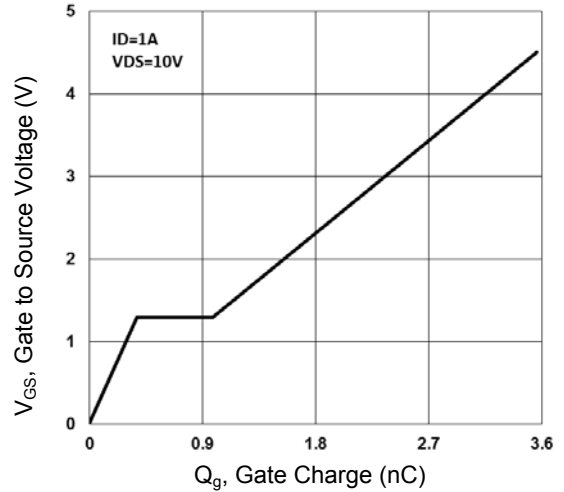

Figure 4. Gate Charge Waveform

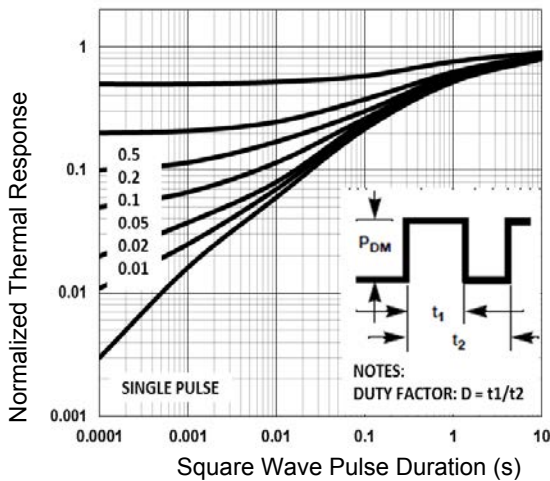

Figure 5. Normalized Transient Impedance

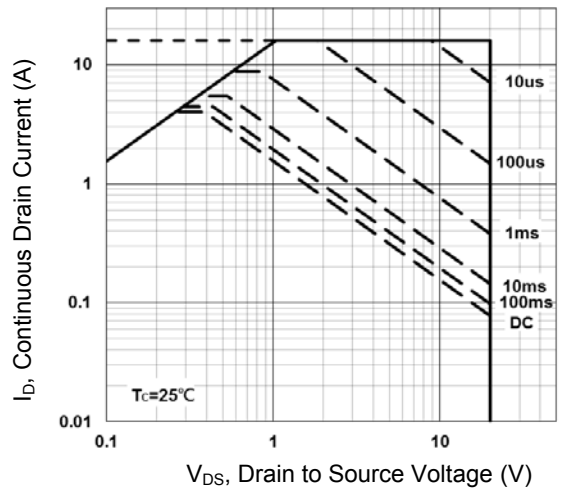

Figure 6. Maximum Safe Operation Area

Typical Electrical and Thermal Characteristic Curves

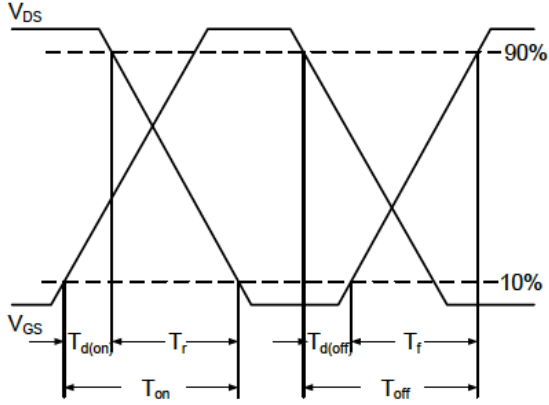

Figure 7. Switching Time Waveform

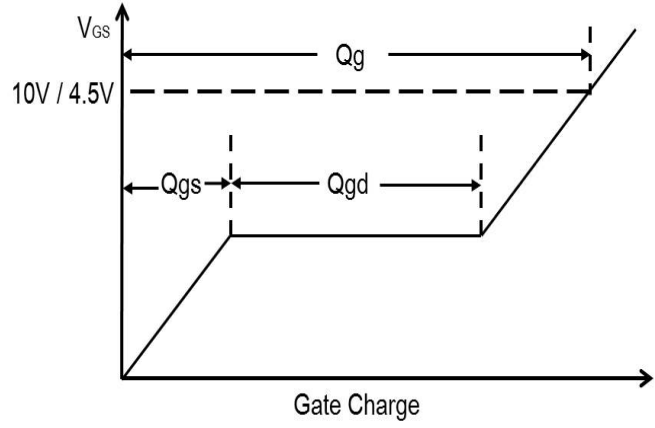
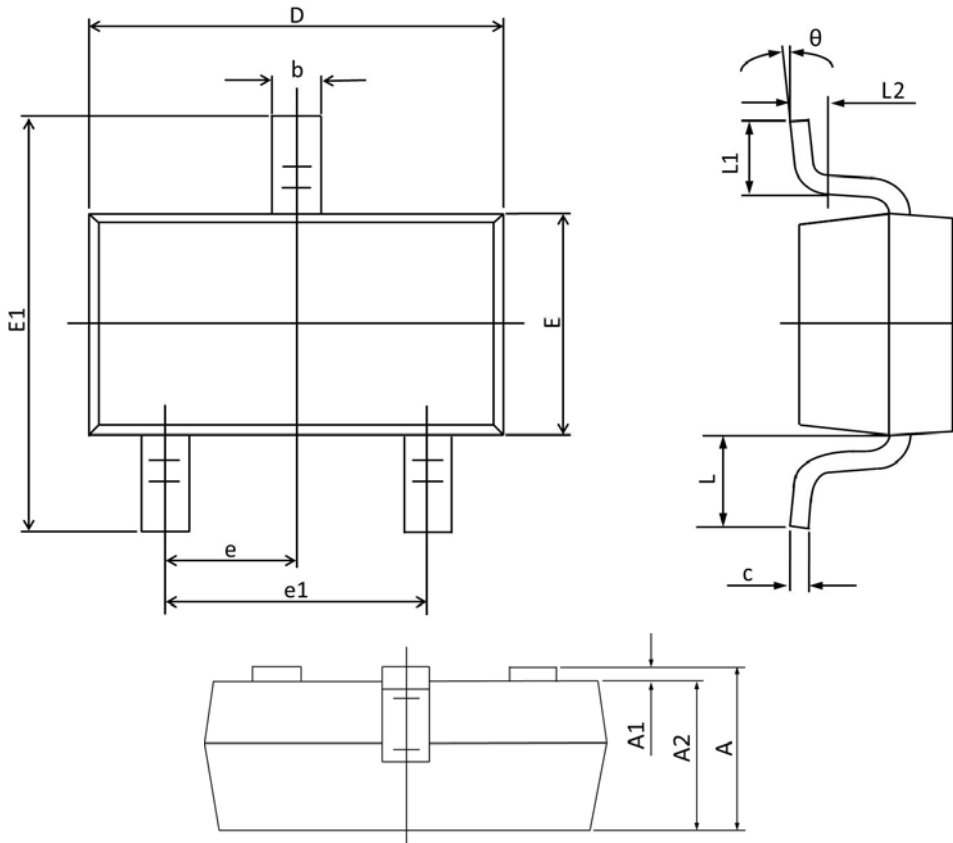

Figure 8. Gate Charge Waveform

Package Outline Dimensions (SOT-23)



| Symbol | Dimensions In Millimeters | | Dimensions In Inches | |
|--------|---------------------------|-------|----------------------|-------|
| | MAX | MIN | MAX | MIN |
| A | 1.150 | 0.900 | 0.045 | 0.035 |
| A1 | 0.100 | 0.000 | 0.004 | 0.000 |
| A2 | 1.050 | 0.900 | 0.041 | 0.035 |
| b | 0.500 | 0.300 | 0.020 | 0.012 |
| c | 0.150 | 0.080 | 0.006 | 0.003 |
| D | 3.000 | 2.800 | 0.118 | 0.110 |
| E | 1.400 | 1.200 | 0.055 | 0.047 |
| E1 | 2.550 | 2.250 | 0.100 | 0.089 |
| e | 0.95 TYP. | | 0.037 TYP. | |
| e1 | 2.000 | 1.800 | 0.079 | 0.071 |
| L | 0.55 REF. | | 0.022 REF. | |
| L1 | 0.500 | 0.300 | 0.020 | 0.012 |
| L2 | 0.25 TYP. | | 0.01 TYP. | |
| θ | 8° | 0° | 8° | 0° |