

Main Product Characteristics

V_{DS}	-20V
$R_{DS(ON)}$	90m Ω
I_D	-1.5A

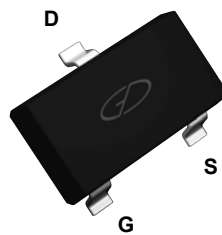

SOT-323

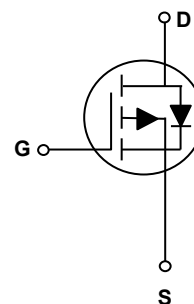

Schematic Diagram

Features and Benefits

- Advanced MOSFET process technology
- Ideal for high efficiency switched mode power supplies
- Low on-resistance with low gate charge
- Fast switching and reverse body recovery



Description

The GSF2315 utilizes the latest techniques to achieve high cell density and low on-resistance. These features make this device extremely efficient and reliable for use in high efficiency switch mode power supply and a wide variety of other applications.

Absolute Maximum Ratings ($T_C=25^\circ\text{C}$ unless otherwise specified)

Parameter	Symbol	Max.	Unit
Drain-Source Voltage	V_{DS}	-20	V
Gate-Source Voltage	V_{GS}	± 10	V
Drain Current-Continuous ($T_C=25^\circ\text{C}$)	I_D	-1.5	A
Drain Current-Continuous ($T_C=100^\circ\text{C}$)		-0.95	A
Drain Current-Pulsed ¹	I_{DM}	-6	A
Power Dissipation ($T_C=25^\circ\text{C}$)	P_D	312	mW
Power Dissipation-Derate Above 25°C		2.5	mW/ $^\circ\text{C}$
Thermal Resistance, Junction-to-Ambient	$R_{\theta JA}$	400	$^\circ\text{C}/\text{W}$
Operating Junction Temperature Range	T_J	-55 To +150	$^\circ\text{C}$
Storage Temperature Range	TSTG	-55 To +150	$^\circ\text{C}$

Electrical Characteristics (T_J=25°C unless otherwise specified)

Parameter	Symbol	Conditions	Min.	Typ.	Max.	Unit
Off Characteristics						
Drain-Source Breakdown Voltage	BVDSS	V _{GS} =0V, I _D =-250μA	-20	-	-	V
BVDSS Temperature Coefficient	ΔBV _{DSS} /ΔT _J	Reference to 25°C, I _D =-1mA	-	-0.01	-	V/°C
Drain-Source Leakage Current (T _J =25°C)	I _{DSS}	V _{DS} =-20V, V _{GS} =0V	-	-	-1	μA
Drain-Source Leakage Current (T _J =125°C)		V _{DS} =-16V, V _{GS} =0V	-	-	-10	μA
Gate-Source Leakage Current	I _{GSS}	V _{GS} =±10V, V _{DS} =0V	-	-	±100	nA
On Characteristics						
Static Drain-Source On-State Resistance	R _{DS(ON)}	V _{GS} =-4.5V, I _D =-1A	-	75	90	mΩ
		V _{GS} =-2.5V, I _D =-1A	-	100	130	
		V _{GS} =-1.8V, I _D =-1A	-	130	170	
Gate Threshold Voltage	V _{GS(th)}	V _{DS} =V _{GS} , I _D =-250μA	-0.3	-0.6	-1	V
V _{GS(th)} Temperature Coefficient	ΔV _{GS(th)}		-	3	-	mV/°C
Forward Transconductance	g _{fs}	V _{DS} =-10V, I _S =-1A	-	2.2	-	S
Dynamic and Switching Characteristics						
Total Gate Charge ^{2,3}	Q _g	V _{DS} =-10V, I _D =-1A, V _{GS} =-4.5V	-	4.8	8	nC
Gate-Source Charge ^{2,3}	Q _{gs}		-	0.5	1	
Gate-Drain Charge ^{2,3}	Q _{gd}		-	1.9	4	
Turn-On Delay Time ^{2,3}	t _{d(on)}	V _{DD} =-10V, I _D =-1A V _{GS} =-4.5V, R _G =25Ω	-	3.5	7	nS
Rise Time ^{2,3}	t _r		-	12.6	24	
Turn-Off Delay Time ^{2,3}	t _{d(off)}		-	32.6	62	
Fall Time ^{2,3}	t _f		-	8.4	16	
Input Capacitance	C _{iss}	V _{DS} =-15V, V _{GS} =0V, F=1.0MHz	-	350	510	pF
Output Capacitance	C _{oss}		-	65	95	
Reverse Transfer Capacitance	C _{rss}		-	50	75	
Drain-Source Diode Characteristics and Maximum Ratings						
Continuous Source Current	I _S	V _G =V _D =0V, Force Current	-	-	-1.5	A
Pulsed Source Current	I _{SM}		-	-	-3	A
Diode Forward Voltage	V _{SD}	T _J =25°C, I _S =-1A, V _{GS} =0V	-	-	-1	V

Note :

1. Repetitive Rating : Pulsed width limited by maximum junction temperature.
2. The data tested by pulsed, pulse width ≤3 00us,duty cycle ≤2 %.
3. Essentially independent of operating temperature.

Typical Electrical and Thermal Characteristic Curves

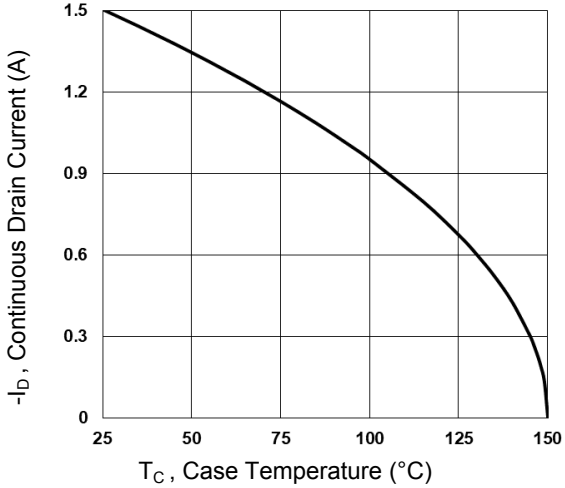

Figure 1. Continuous Drain Current vs. T_c

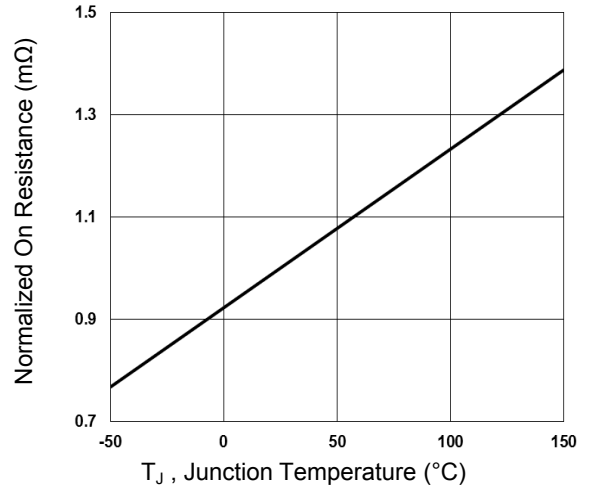

Figure 2. Normalized $R_{DS(on)}$ vs. T_j

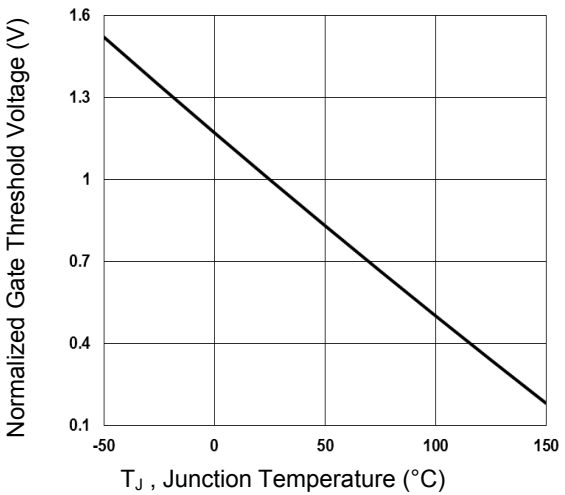

Figure 3. Normalized V_{th} vs. T_j

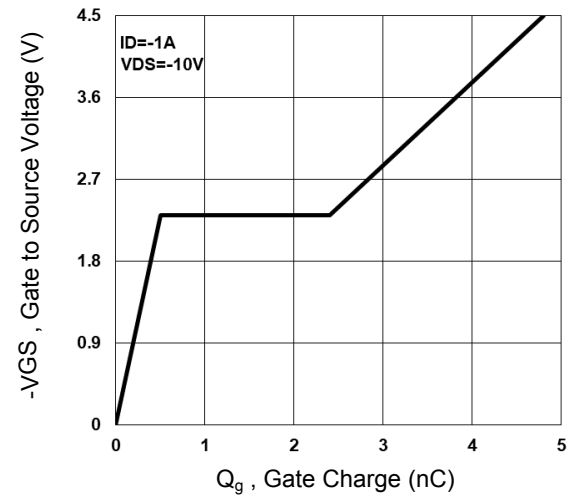

Figure 4. Gate Charge Waveform

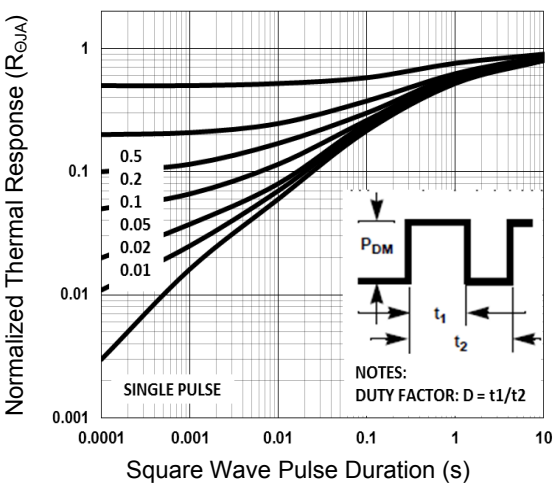

Figure 5. Normalized Transient Response

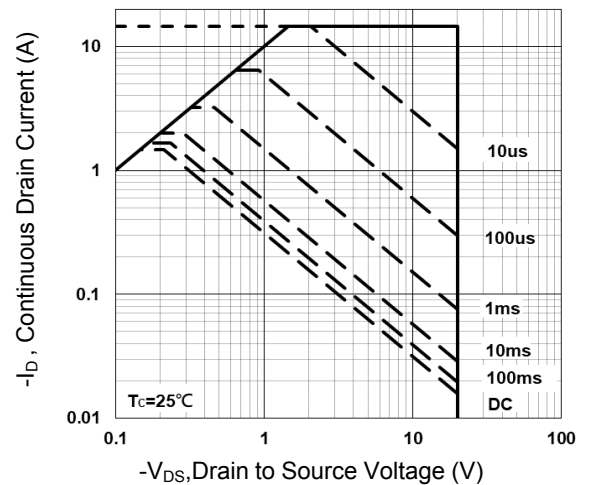

Figure 6. Maximum Safe Operation Area

Typical Electrical and Thermal Characteristic Curves

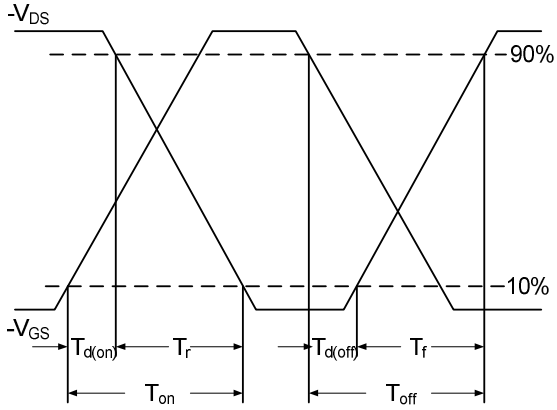

Figure 7. Switching Time Waveform

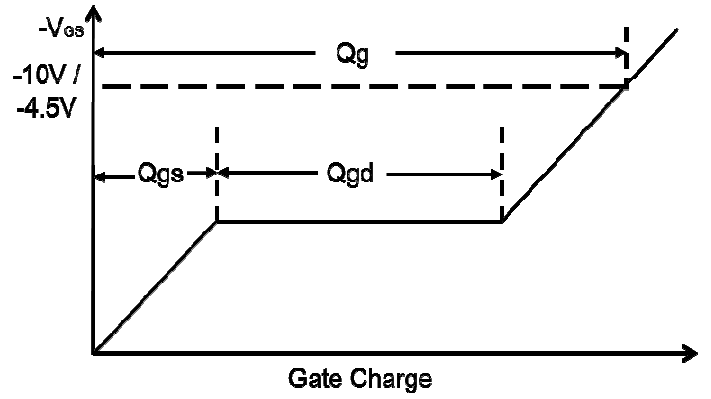
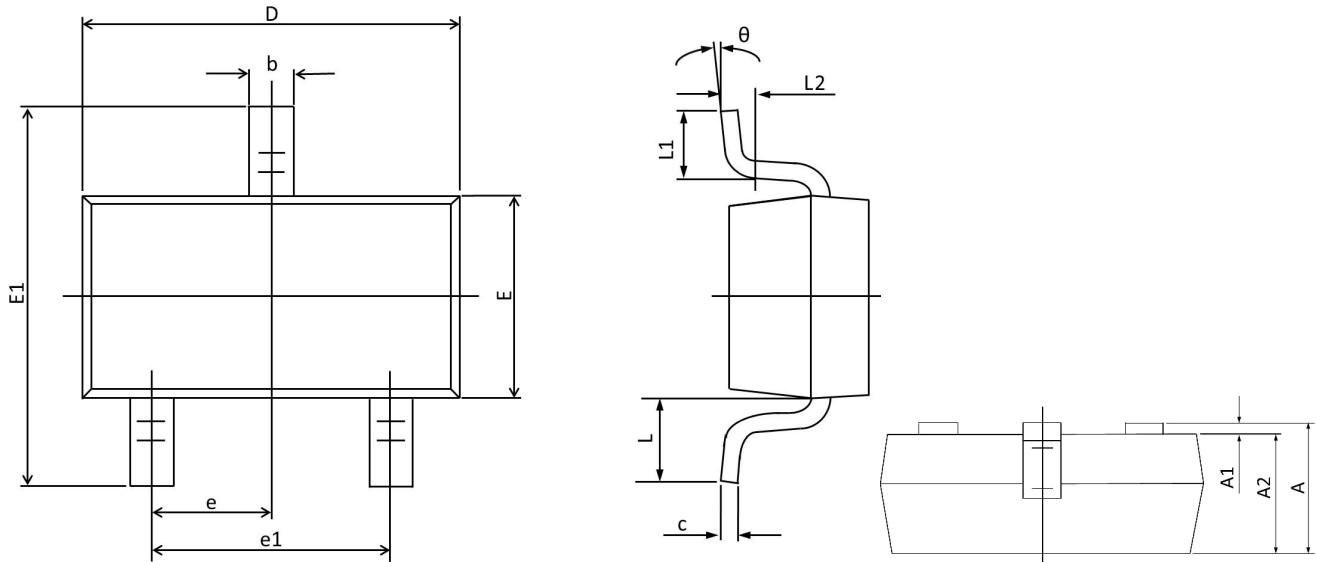

Figure 8. Gate Charge Waveform

Package Outline Dimensions (SOT-323)



Symbol	Dimensions In Millimeters		Dimensions In Inches	
	MAX	MIN	MAX	MIN
A	1.100	0.800	0.043	0.031
A1	0.100	0.000	0.004	0.000
A2	1.000	0.800	0.039	0.031
b	0.400	0.200	0.016	0.008
c	0.250	0.080	0.010	0.003
D	2.200	1.800	0.087	0.071
E	1.350	1.150	0.053	0.045
E1	2.450	1.800	0.096	0.071
e	0.65BSC		0.026BSC	
e1	1.400	1.200	0.055	0.047
L	0.525REF.		0.021REF.	
L1	0.460	0.150	0.018	0.006
L2	0.200	0.000	0.008	0.000
θ	8°	0°	8°	0°