

KBPC15 Series

Glass Passivated Single-Phase Bridge Rectifiers
 Voltage Range 50 to 1000V Forward Current 15A

Features

- Surge overload rating - 200~400A peak
- High surge current capability
- Low thermal resistance
- Low forward voltage drop
- Mounting position: Any
- Electrically isolated base - 1800V
- Solderable 0.25" FASTON terminals
- Solder dip 275 °C max. 7 s, per JESD 22-B106
- Terminals: Tin plated leads,
 Solderable per J-STD-002 and JESD22-B102,
 Suffix letter "W" added to indicate wire leads(e.g. KBPC1510W)

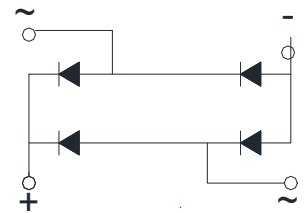
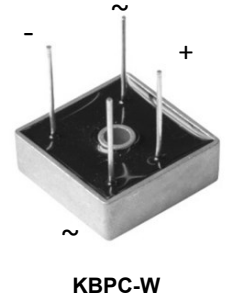
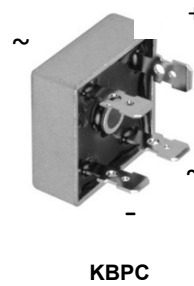

Schematic Diagram

Maximum Ratings and Electrical Characteristics

$T_A=25^{\circ}\text{C}$ Unless otherwise specified

Parameter	Symbol	KBPC	KBPC	KBPC	KBPC	KBPC	KBPC	KBPC	Unit
		15005	1501	1502	1504	1506	1508	1510	
		KBPC 15005W	KBPC 1501W	KBPC 1502W	KBPC 1504W	KBPC 1506W	KBPC 1508W	KBPC 1510W	
Repetitive Peak Reverse Voltage	V_{RRM}	50	100	200	400	600	800	1000	V
Maximum Instantaneous Forward Voltage Drop per Diode ($I_{FM}=7.5A$)	V_{FM}	1.1							V
Maximum DC Reverse Current at Rated DC Blocking Voltage per Diode ($V_{RM}=V_{RRM}$)	I_{RRM}	10							μA
Average Rectified Output Current @60Hz Sine Wave, R-load, With Heatsink, $T_c=55^{\circ}\text{C}$	I_O	15							A
Surge(Non-repetitive) Forward Current @60Hz Half- sine Wave, 1 cycle, $T_A=25^{\circ}\text{C}$	I_{FSM}	300							A
Current Squared Time @ $1\text{ms}\leq t\leq 8.3\text{ms}$ $T_J=25^{\circ}\text{C}$, Rating of Per Diode	I^2t	375							A^2S
Storage Temperature	T_{STG}	-55 to +150							$^{\circ}\text{C}$
Junction Temperature	T_J	-55 to +150							$^{\circ}\text{C}$
Dielectric Strength, Terminals to Case, AC 1 minute	V_{dis}	2.5							KV
Thermal Resistance, Between Junction and Case, With Heatsink	$R_{\theta J-C}$	3.4							$^{\circ}\text{C/W}$

Ratings and Characteristics Curves

($T_A = 25^\circ\text{C}$ unless otherwise noted)

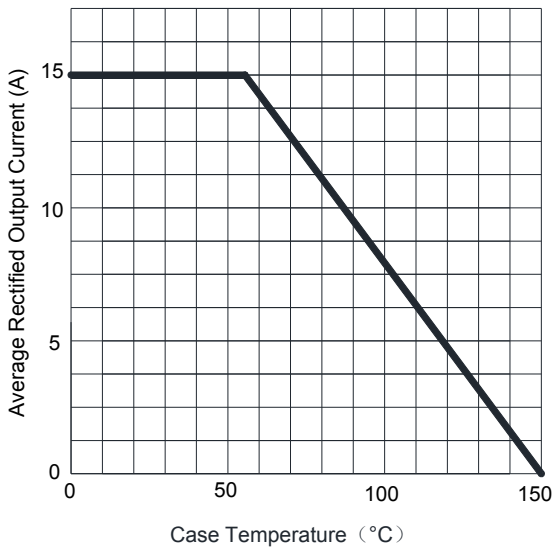

Figure 1. I_o - T_c Curve

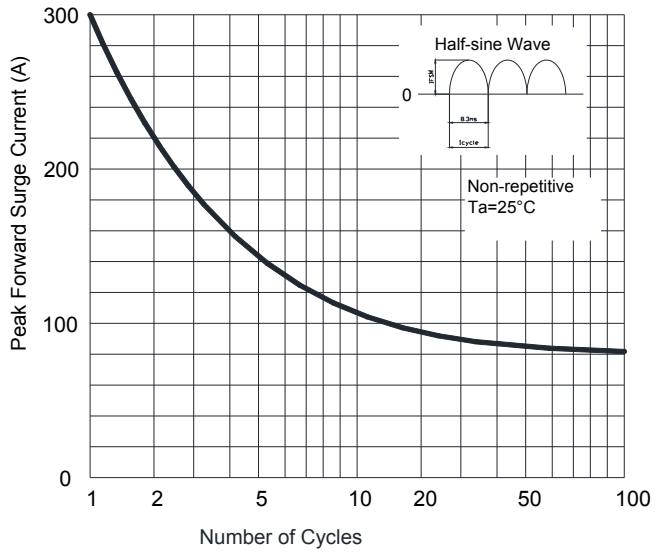

Figure 2. Surge Forward Current Capability

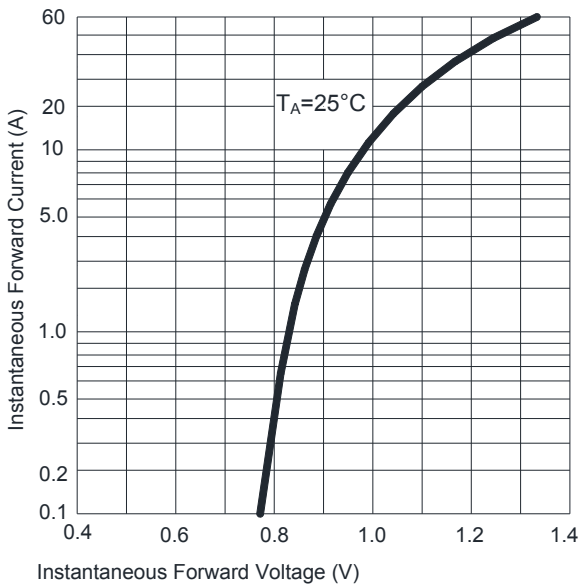

Figure 3. Instantaneous Forward Voltage

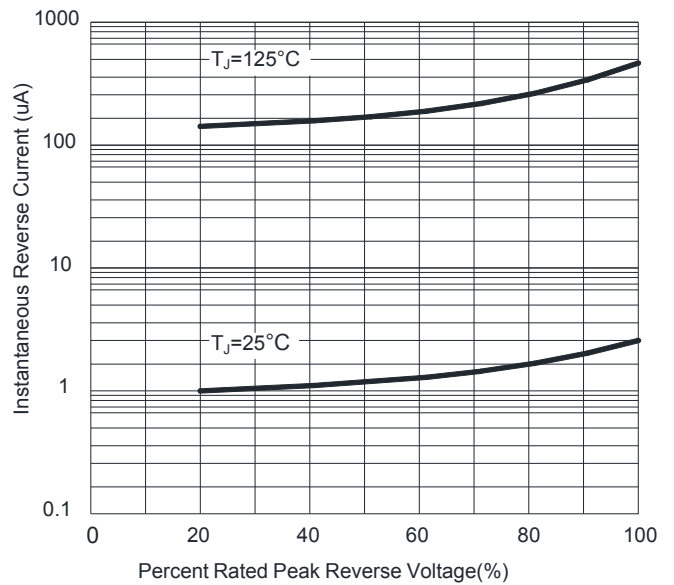
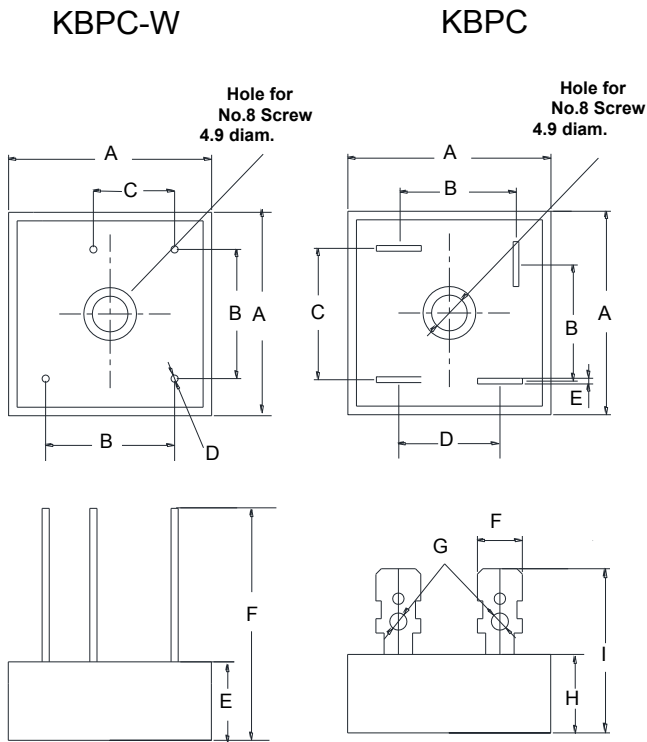

Figure 4. Typical Reverse Characteristics

Package Outline Dimensions



Dimensions in millimeters

KBPC-W		
Dim	Min	Max
A	28.2	28.8
B	17.1	19.1
C	10.4	12.4
D	0.95	1.05
E	7.6	8.2
F	30	

KBPC		
Dim	Min	Max
A	28.2	28.8
B	15.3	17.3
C	17.1	19.1
D	13.2	15.2
E	0.75	0.85
F	6.2	6.4
G	2.4	2.6
H	7.6	8.2
I	19	