

GL1506B thru GL1508B

Glass Passivated Bridge Rectifiers
 Reverse Voltage 600 to 800V Forward Current 15A

Features

- Glass passivated chip junction
- Thin single in-line package
- Ideal for printed circuit boards
- High surge current capability
- High case dielectric strength of 2500 V_{RMS}
- Low forward voltage drop
- Solder dip 260 °C, 10s
- Compliant to RoHS Directive 2002/95/EC and in accordance to WEEE 2002/96/EC

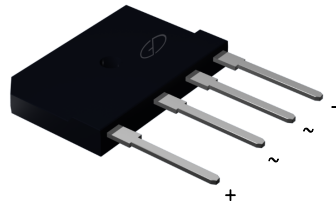

Package: GBJ(5S)

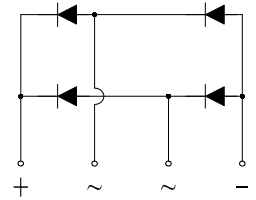

Schematic Diagram

Mechanical Data

- Case: GBJ(5S), molded epoxy body , Epoxy meets UL 94V-0 flammability rating
- Terminals: Matte tin plated leads, solderable per J-STD-002 and JESD22B-106
- Polarity: As marked on body
- Mounting Torque: 10cm·kg(8.8 inches·lbs)maximum
- Recommended Torque: 5.7cm·kg(5 inches·lbs)



Applications

General purpose used in AC-DC full wave rectification for switching power supplies, home appliances, office equipment and industrial automotive applications.

Maximum Ratings (T_A = 25°C unless otherwise noted)

Parameter	Symbol	GL1506B	GL1508B	Unit
Maximum Repetitive Peak Reverse Voltage	V _{RRM}	600	800	V
Maximum RMS Voltage	V _{RMS}	420	560	V
Maximum DC Blocking Voltage	V _{DC}	600	800	V
Maximum Average Forward Rectified Output Current at	T _C =110°C ⁽¹⁾	I _{F(AV)1}	15	A
	T _A =25°C ⁽²⁾	I _{F(AV)2}	3.7	
Peak Forward Surge Current (8.3 ms single half sine-wave superimposed on rated load, JEDEC Method)	I _{FSM}	280		A
Dielectric Strength (terminals to case, AC)	V _{ISO}	2500		V
Operating Junction and Storage Temperature Range	T _J , T _{STG}	- 55 to + 150		°C

Notes: (1) Unit case mounted with heatsink

(2) Unit case mounted on PCB without heatsink

Thermal Characteristics (T_A = 25°C unless otherwise noted)

Parameter	Symbol	GL1506B	GL1508B	Unit
Maximum Thermal Resistance	R _{θJC} ⁽¹⁾	1.5		°C/W
	R _{θJA} ⁽²⁾	25		

Notes: (1) Thermal resistance from junction to case, Unit case mounted with heatsink

(2) Thermal resistance from junction to ambient, Unit case mounted on PCB without heatsink

Electrical Characteristics (T_A = 25°C unless otherwise noted)

Parameter	Test Conditions	Symbol	GL1506B	GL1508B	Unit
Maximum Instantaneous Forward Voltage Drop per Leg	I _F =7.5 A	T _A =25°C	0.91		V
		T _A =125°C	0.83		
Maximum DC Reverse Current at Rated DC Blocking Voltage	T _A =25°C		5		μA
	T _A =125°C		250		
Typical Reverse Recovery Time	I _F = 0.5 A, I _R = 1.0 A, I _{rr} = 0.25 A	T _{RR}	4.0		μs

Ratings and Characteristics Curves

(T_A = 25°C unless otherwise noted)

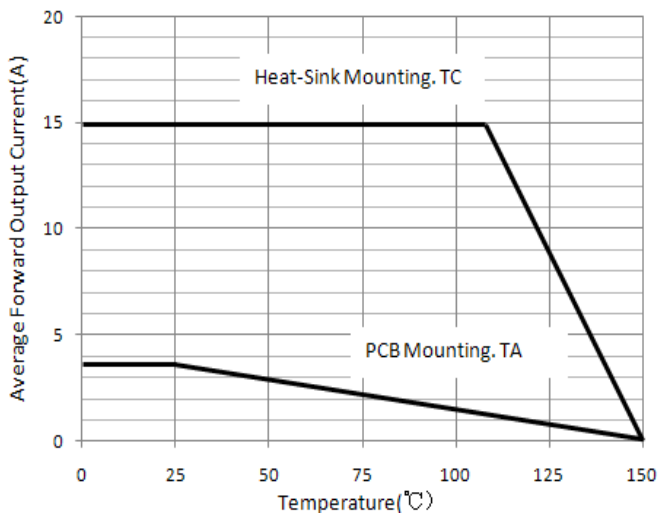

Figure 1. Derating Curve Output Rectified Current

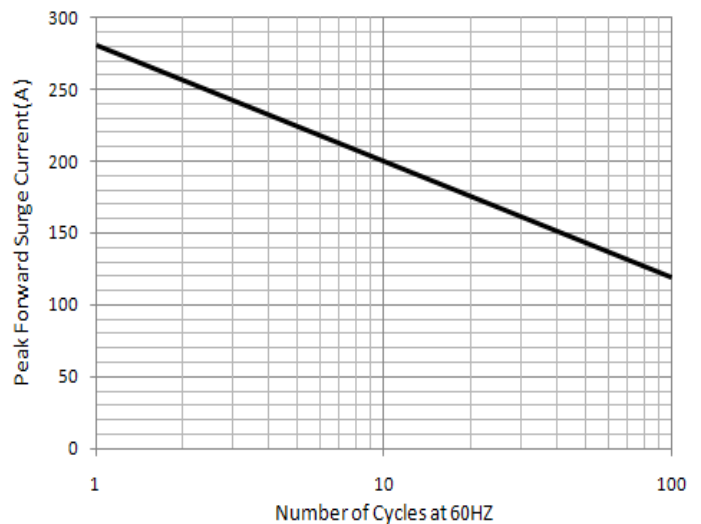

Figure 2. Maximum Non-Repetitive Peak Forward Surge Current Per Leg

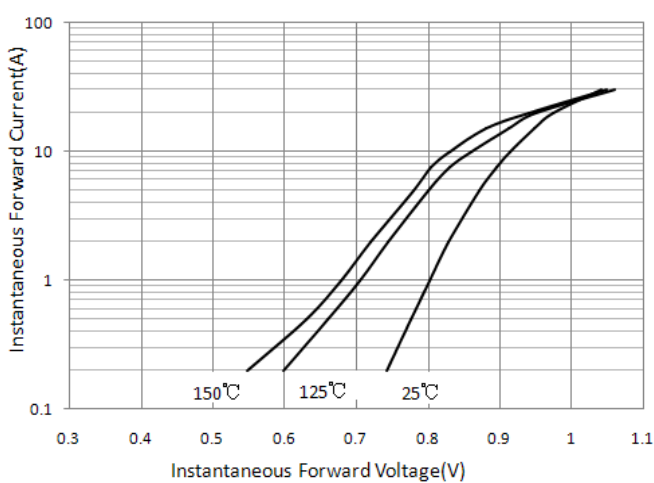

Figure 3. Typical Forward Characteristics Per Leg

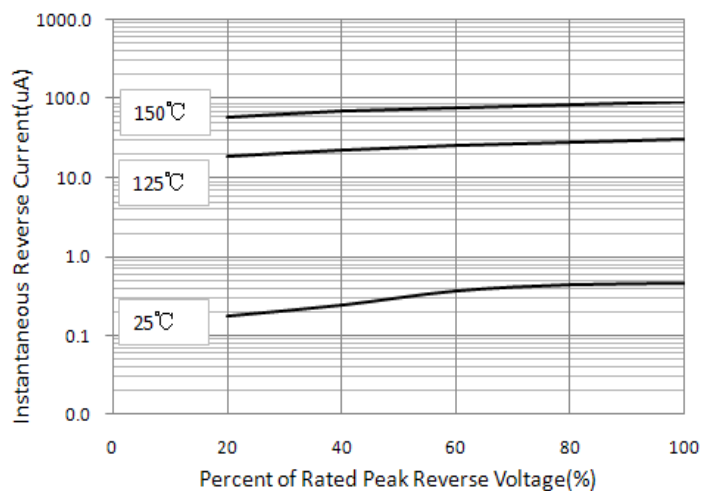

Figure 4. Typical Reverse Characteristics Per Leg

GL1506B thru GL1508B

Glass Passivated Bridge Rectifiers
 Reverse Voltage 600 to 800V Forward Current 15A

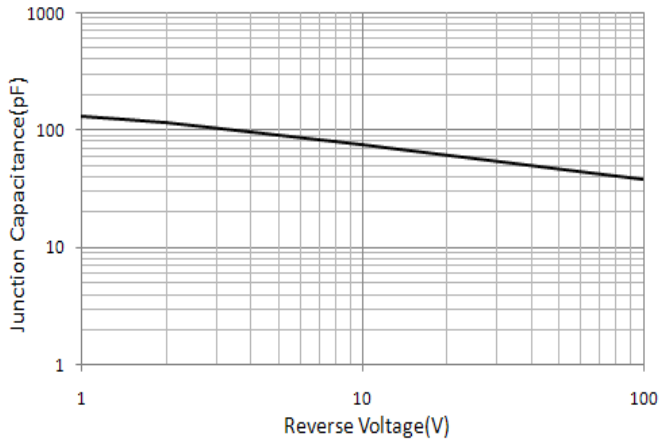
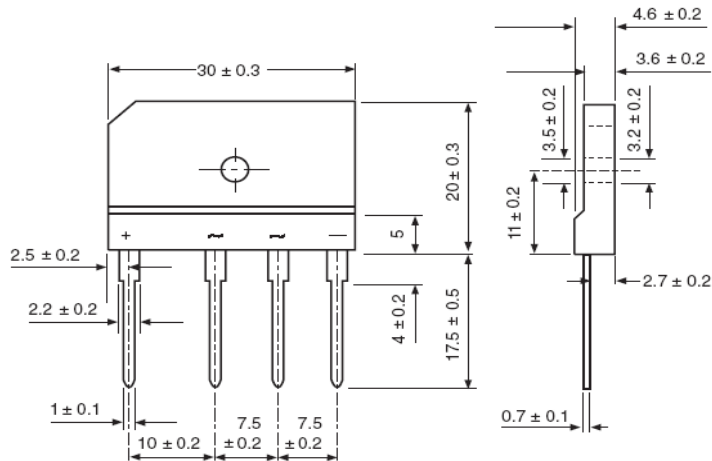

Figure 5. Typical Junction Capacitance Per Leg

Package Outline Dimensions

in millimeters

GBJ(5S)



Ordering Information (example)

P/N	Unit Weight (g)	Base Quantity	Delivery Mode
GL1506B	7.141	20	Tube
GL1506B	7.141	40	Paper tray