



GBJ6A thru GBJ6M

Glass Passivated Single-Phase Bridge Rectifiers
Reverse Voltage 50 to 1000 Volts Forward Current 6.0 Amperes

Features

- ◆ Thin Single In-Line package
- ◆ Ideal for printed circuit boards
- ◆ Glass passivated chip junction
- ◆ High surge current capability
- ◆ High case dielectric strength of 2500 V_{RMS}
- ◆ Plastic package has Underwriters Laboratory Flammability Classification 94V-0

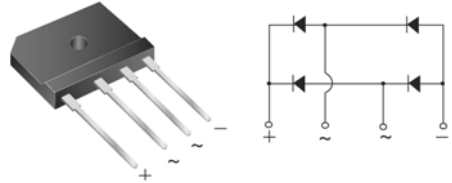

Mechanical Data

- ◆ Case: GBJ(5S)
Epoxy meets UL-94V-0 Flammability rating
- ◆ Terminals: Plated leads solderable per MIL-STD-750, Method 2026
- ◆ High temperature soldering guaranteed:
260°C/10 seconds, 0.375 (9.5mm) lead length,
5lbs.(2.3kg) tension
- ◆ Polarity: As marked on body
- ◆ Mounting Torque: 10 cm-kg (8.8 inches-lbs) max.
- ◆ Recommended Torque: 5.7cm-kg (5 inches-lbs)

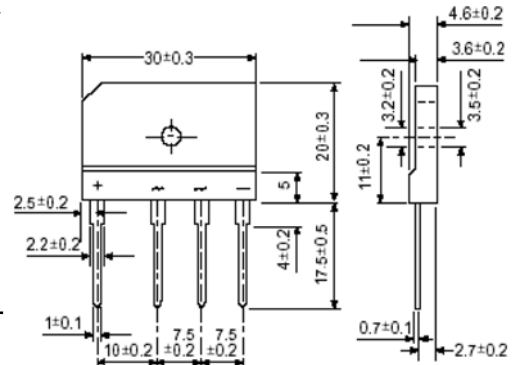

Typical Applications

General purpose use in ac-to-dc bridge full wave rectification for Switching Power Supply, Home Appliances, Office Equipment, Industrial Automation applications

Maximum Ratings and Electrical Characteristics

Rating at 25°C ambient temperature unless otherwise specified.

Parameter	Symbols	GBJ6A	GBJ6B	GBJ6D	GBJ6G	GBJ6J	GBJ6K	GBJ6M	Units
Maximum repetitive peak reverse voltage	V_{RRM}	50	100	200	400	600	800	1000	Volts
Maximum RMS voltage	V_{RMS}	35	70	140	280	420	560	700	Volts
Maximum DC blocking voltage	V_{DC}	50	100	200	400	600	800	1000	Volts
Maximum average forward rectified output current at $T_C=100^\circ\text{C}$ $T_A=25^\circ\text{C}$	$I_{F(AV)}$				6.0 ⁽¹⁾				Amps
Peak forward surge current, 8.3ms single half sine-wave superimposed on rated load (JEDEC Method)	I_{FSM}				150.0				Amps
Rating for fusing (t<8.3ms)	I^2t				93				A ² sec
Maximum instantaneous forward voltage drop per leg at 3.0A	V_F				1.0				Volt
Maximum DC reverse current at rated DC blocking voltage per leg $T_A=25^\circ\text{C}$ $T_A=125^\circ\text{C}$	I_R				5				uA
Typical thermal resistance per leg	$R_{\theta JA}$ $R_{\theta JC}$				22 ⁽²⁾				°C/W
Dielectric strength (Terminals to case, AC 1 minute)	V_{ISO}				2500				Volts
Operating junction and storage temperature range	T_J, T_{STG}				-55 to +150				°C

- Notes:**
1. Unit case mounted on 9.5x9.5x0.15cm thick Al plate heatsink
 2. Units mounted on P.C.B. with 0.5 x 0.5" (13 x 13 mm) copper pads and 0.375" (9.5 mm) lead length
 3. Recommended mounting position is to bolt down on heatsink with silicone thermal compound for maximum heat transfer with #6 screw

RATINGS AND CHARACTERISTIC CURVES

($T_A = 25^\circ\text{C}$ unless otherwise noted)

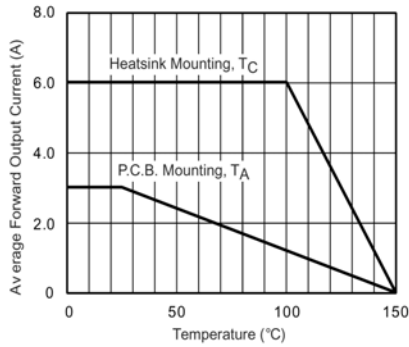

Figure 1. Derating Curve Output Rectified Current

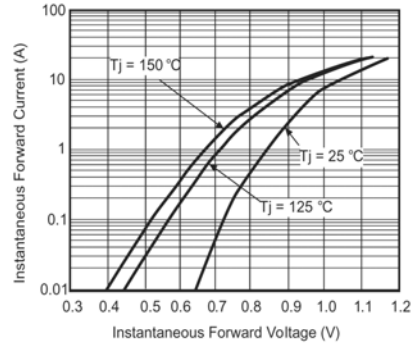

Figure 3. Typical Forward Characteristics Per Leg

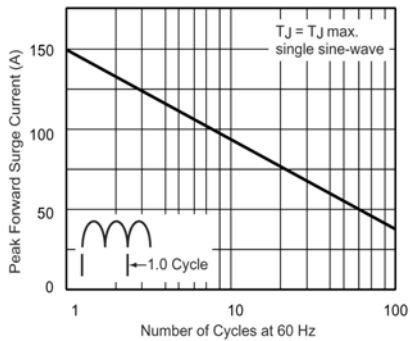

Figure 2. Maximum Non-Repetitive Peak Forward Surge Current Per Leg

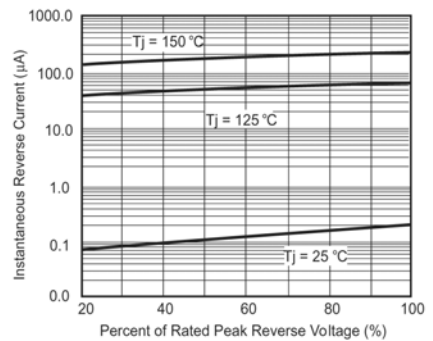

Figure 4. Typical Reverse Characteristics Per Leg

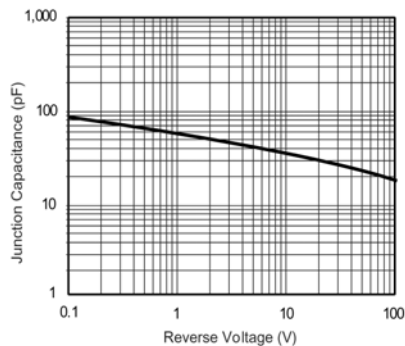

Figure 5. Typical Junction Capacitance Per Leg

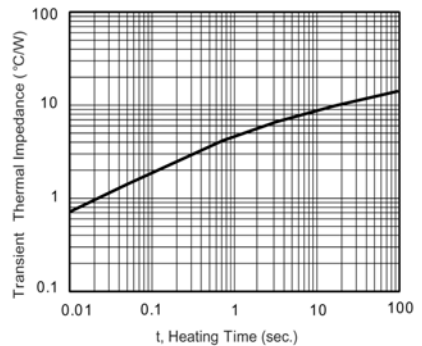

Figure 6. Typical Transient Thermal Impedance