

Features

- 100 Watts peak pulse power ($t_p = 8/20\mu s$)
- SOD-923 package
- Bidirectional configurations
- Protects one I/O port
- Low clamping voltage
- Low Leakage current
- ESD-immunity acc. IEC 61000-4-2 $\pm 30KV$ contact
 $\pm 30KV$ air
- IEC 61000-4-4 (EFT) 40A (5/50ns)
- IEC 61000-4-5 (Lightning) 24A (8/20 μs)

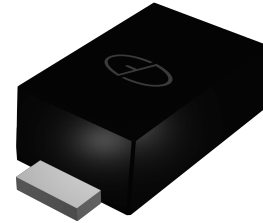

SOD-923

Applications

- Cell Phone
- PDA
- Notebook
- Digital Cameras
- Portable Instrumentation
- Audio and Video equipment

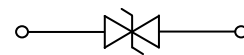

Schematic Diagram

Absolute Maximum Ratings ($T_A=25^\circ C$ unless otherwise specified)

Parameter	Symbol	Value	Unit
Peak Pulse Power ($T_P=8/20\mu S$)	P_{PP}	100	W
Peak Pulse Current ($t_p = 8/20\mu S$)	I_{PP}	8	A
Junction Temperature	T_J	-55 to +125	$^\circ C$
Storage temperature	T_{STG}	-55 to +150	$^\circ C$

Electrical Characteristics ($T_A=25^\circ C$ unless otherwise specified)

Parameter	Symbol	Condition	Min	Typ	Max	Unit
Reverse stand-off Voltage	V_{RWM}	-	-	-	5	V
Reverse Breakdown Voltage	V_{BR}	$I_T=1mA$	6	6.8	8	V
Reverse Leakage Current	I_R	$V_R=5V$	-	-	1	μA
Clamping Voltage	V_C	$I_{PP}=1A, T_P=8/20\mu S$	-	-	10	V
	V_C	$I_{PP}=8A, T_P=8/20\mu S$	-	-	13	V
Junction Capacitance	C_J	$V_R=0V, f=1MHz$	-	15	-	pF

Typical Characteristic Curves

Fig.1 Peak Pulse Power Rating Curve

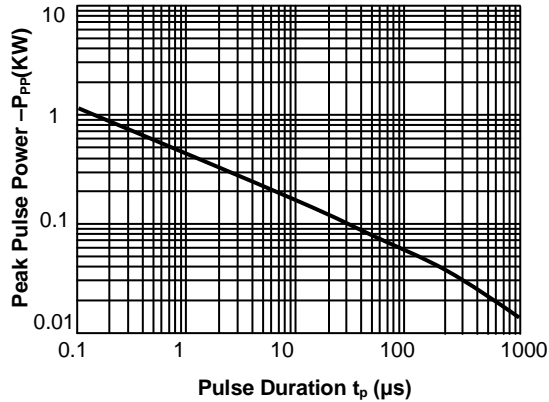

Fig.2 Pulse Derating Curve

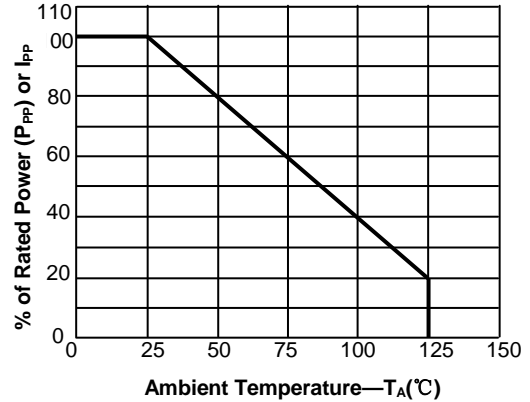

Fig.3 Pulse Waveform-8/20μs

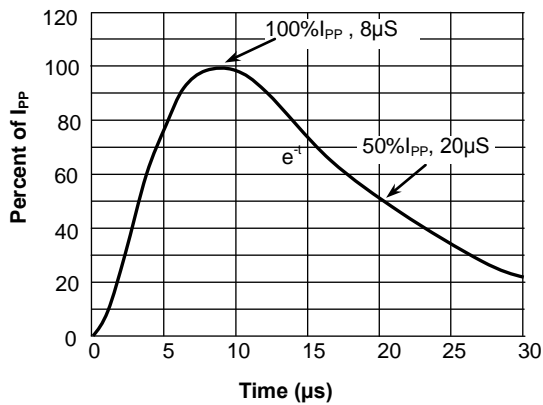
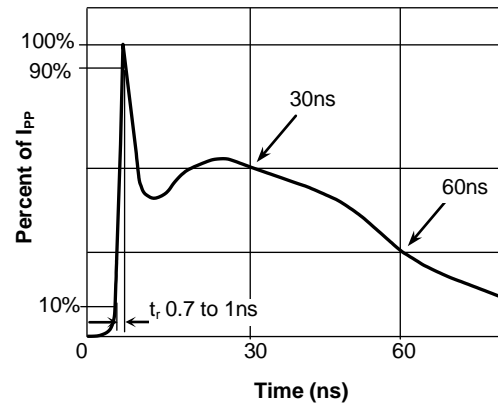
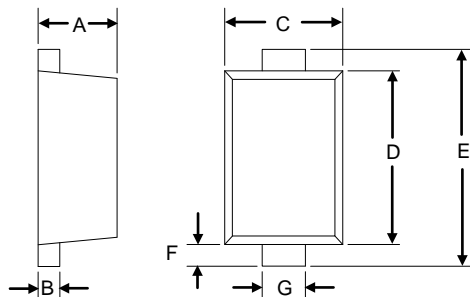

Fig.4 Pulse Waveform-ESD(IEC61000-4-2)



Product Dimensions



SOD-923

Dim	millimeters	
	min	max
A	0.34	0.40
B	0.07	0.17
C	0.55	0.65
D	0.75	0.85
E	0.95	1.05
F	0.05	0.15
G	0.15	0.25

PAD Dimensions

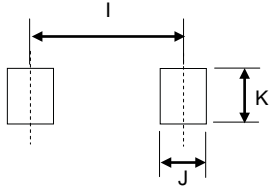

Dim	millimeters
I	0.90
J	0.30
K	0.35

Package Information

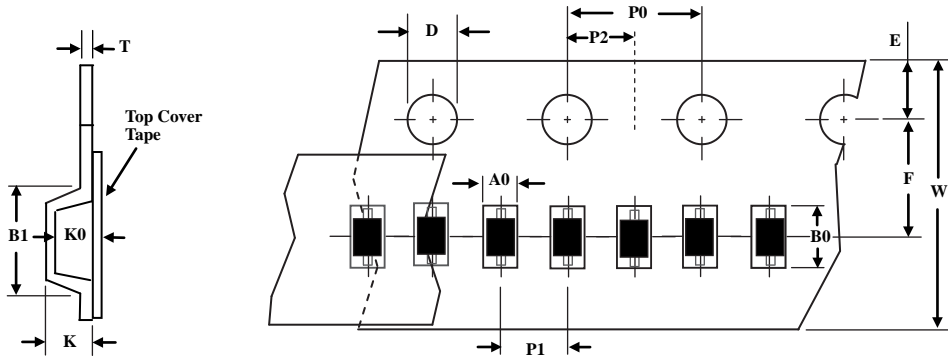

TapeSize(W)	B1 max	D	E	F	K max	P0	P1	P2	T max	W max
8	4.55	1.55±0.05	1.75±0.1	3.5±0.05	2.4	4.0±0.1	2.0±0.05	2.0±0.05	0.6	8.3

Note:1.Unit : mm

2. A0, B0, and K0 are determined by component size. The clearance between the components and the cavity must be within 0.05mm min to 0.50 mm max. The component cannot rotate more than 10° within the determined cavity.

Marking

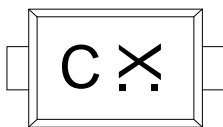

× : DateCode

Order Information

Device	Package	Net Weight	Carrier	Quantity	HSF Status
SES5VD923-2B	SOD-923	0.0006g	Tape & Reel	8000pcs / Reel	RoHS compliant