

Features

- 350W peak pulse power (tp= 8/20µs)
- SOD-323 package
- Fast response time, typically < 1 ns
- Excellent clamping voltage
- Low leakage current
- IEC 61000-4-2 ±15kV (Air) ESD protection
- IEC 61000-4-2 ±8kV (Contact) ESD protection
- IEC 61000-4-4 40A (5/50ns) EFT protection
- RoHS compliant

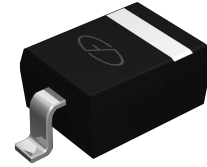

SOD-323

Applications

- Laptop computers
- Cellular phones
- Digital cameras
- PDAs

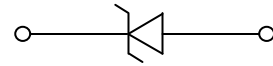

Schematic Diagram

Absolute Maximum Ratings

(T_A=25°C unless otherwise specified)

Parameter	Symbol	Value	Unit
Peak Pulse Power (T _P =8/20µS)	P _{PP}	350	W
Peak Pulse Current (T _P = 8/20µS)	I _{PP}	9.8	A
Junction Temperature	T _J	-55 to +150	°C
Storage Temperature	T _{STG}	-55 to +150	°C

Electrical Characteristics

(T_A=25°C unless otherwise specified)

Parameter	Symbols	Conditions	Min	Typ	Max	Units
Reverse stand-off voltage	V _{RWM}	-	-	-	5	V
Reverse Breakdown Voltage	V _{BR}	I _T =1mA	6	-	-	V
Reverse Leakage Current	I _R	V _R =5V	-	-	1	µA
Clamping Voltage	V _C	I _{PP} =1A, T _P =8/20µs	-	-	9.8	V
Clamping Voltage	V _C	I _{PP} =9.8A, T _P =8/20µs	-	17	-	V
Junction Capacitance	C _J	V _R =0V, f=1MHz	-	90	-	pF

Typical Characteristic Curves

Fig.1 Peak Pulse Power vs Pulse Time

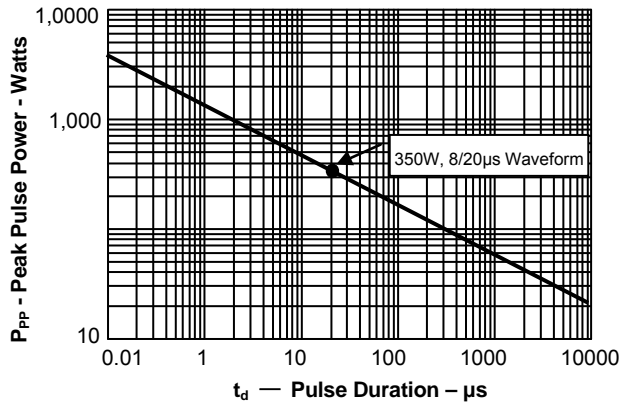

Fig.2 Pulse WaveForm-8/20μs

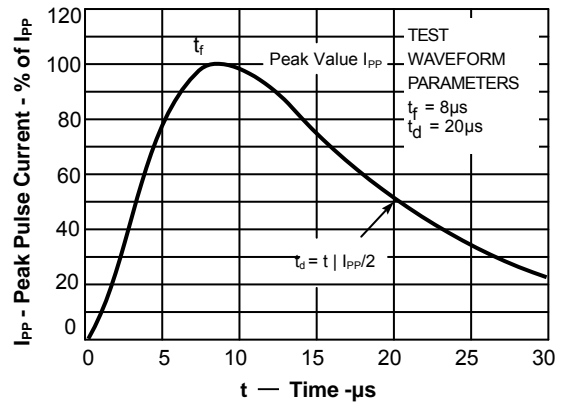

Fig.3 Power Derating Curve

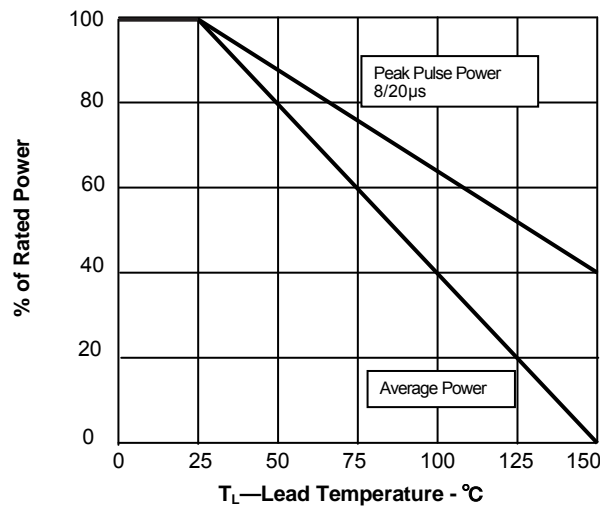
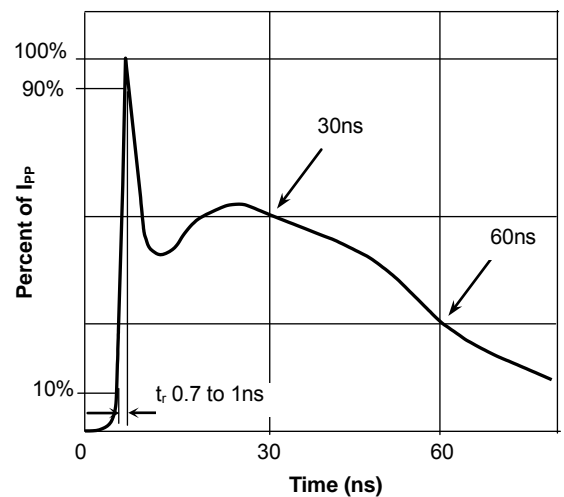
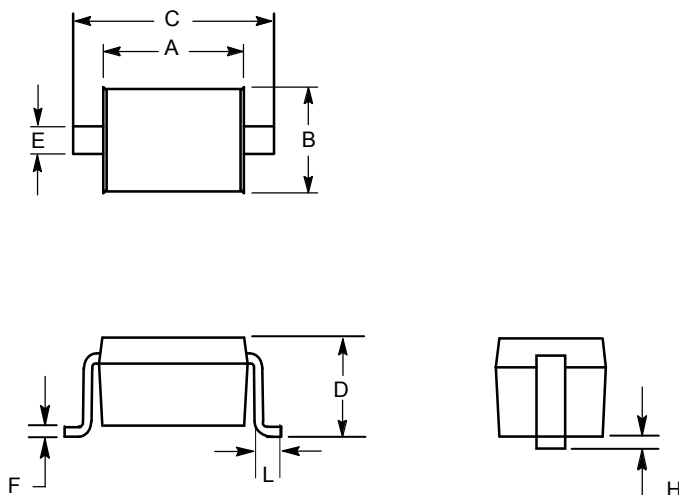

Fig.4 Pulse Waveform-ESD(IEC61000-4-2)



Product Dimensions



SOD-323

Dim	millimeters	
	min	max
A	1.60	1.90
B	1.15	1.45
C	2.39	2.70
D	0.80	1.10
E	0.25	0.40
F	0.10	0.20
H		0.10
L	0.20	-

PAD Dimensions

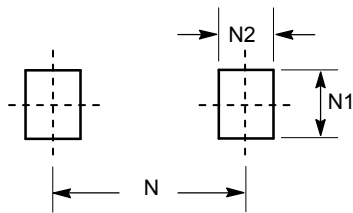

Dim	millimeters
N1	0.80
N2	0.80
N	3.00

Package Information

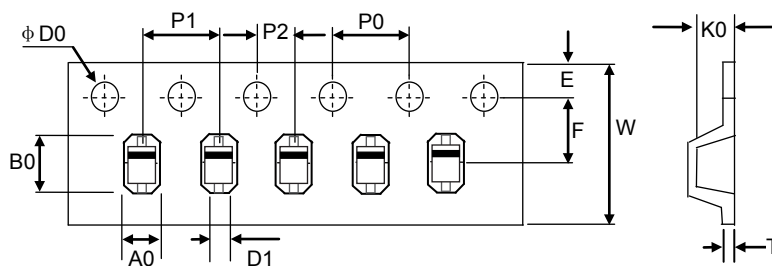

Unit:mm

A0	B0	K0	D1	$\phi D0$	E	F	W	P0	P1	P2	T
1.52±0.10	2.90±0.10	1.35±0.10	1.0±0.25	1.50±0.10	1.75± 0.10	3.50± 0.05	8.00± 0.10	4.00±0.10	4.00±0.10	2.00±0.05	0.24~0.27

Marking



Order Information

Device	Package	Net Weight	Carrier	Quantity	HSF Status
SES5VD323-2U	SOD-323	0.0045g	Tape & Reel	3000pcs	RoHS compliant