

**Features**

- 200 Watts peak pulse power ( $t_p = 8/20\mu s$ )
- SOT-23 package
- Protects one bidirectional or two unidirectional lines
- Fast response time, typically <1 ns
- Excellent clamping voltage
- Low leakage current
- IEC 61000-4-2  $\pm 15kV$  (Air) ESD protection
- IEC 61000-4-2  $\pm 8kV$  (Contact) ESD protection
- IEC 61000-4-5 16A (8/20 $\mu s$ ) Lightning protection
- RoHS compliant

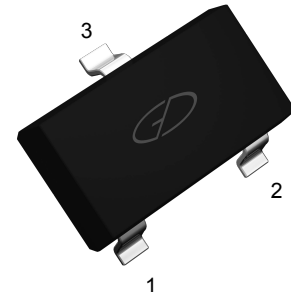

**Package: SOT-23**

**Applications**

- Cellular Handsets and Accessories
- Portable Electronics
- Control & Monitoring Systems
- Servers, Notebooks, and Desktop Pcs
- Set-Top Box
- Communication Systems

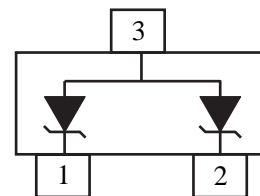

**Schematic Diagram**

**Absolute Maximum Ratings**

( $T_A=25^\circ C$  unless otherwise specified)

Rating	Symbols	Value	Units
Peak Pulse Power ( $t_p=8/20\mu S$ )	$P_{PP}$	200	W
Peak Pulse Current ( $t_p=8/20\mu S$ )	$I_{PP}$	16	A
Operating Temperature	$T_J$	-55 to +150	$^\circ C$
Storage temperature	$T_{STG}$	-50 to +150	$^\circ C$

**Electrical Characteristics**

( $T_A=25^\circ C$  unless otherwise specified)

Parameter	Symbols	Conditions	Min	Typ	Max	Units
Reverse stand-off Voltage	$V_{RWM}$	-	-	-	3.3	V
Reverse Breakdown Voltage	$V_{BR}$	$I_T=1mA$	5	-	5.9	V
Reverse Leakage Current	$I_R$	$V_{RWM}=3.3V$	-	-	10	$\mu A$
Clamping Voltage	$V_C$	$I_{PP}=16A, T_p=8/20\mu S$	-	-	13	V
Junction Capacitance	$C_J$	$V_R=0V, f=1MHz$	-	120		pF

**Typical Characteristic Curves**

**Fig.1 Peak Pulse Power vs Pulse Time**

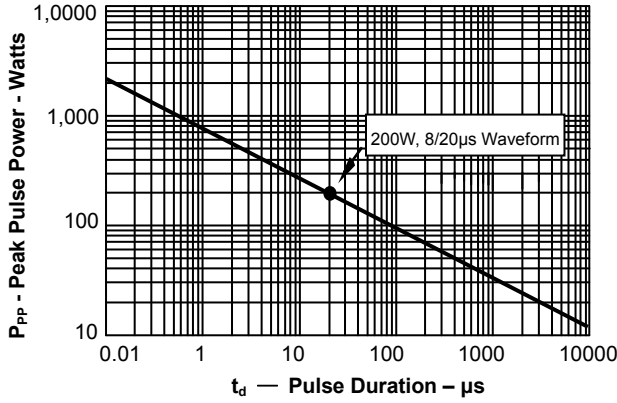

**Fig.2 Pulse WaveForm-8/20μs**

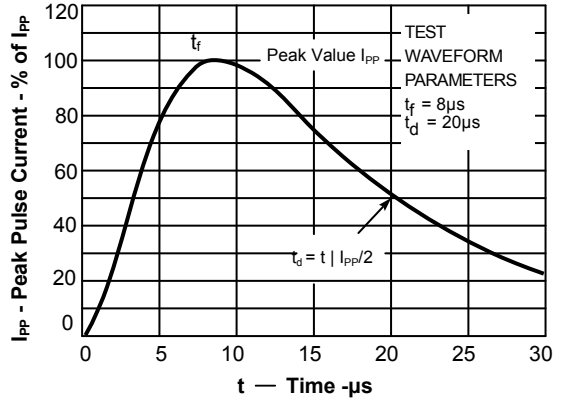

**Fig.3 Power Derating Curve**

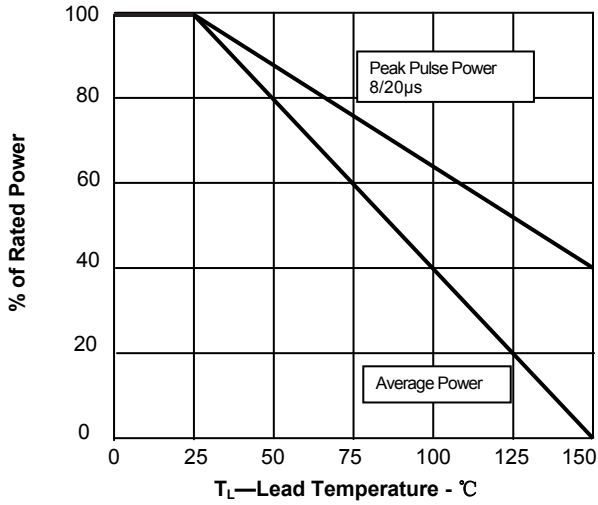

**Fig.4 Pulse Waveform-ESD(IEC61000-4-2)**

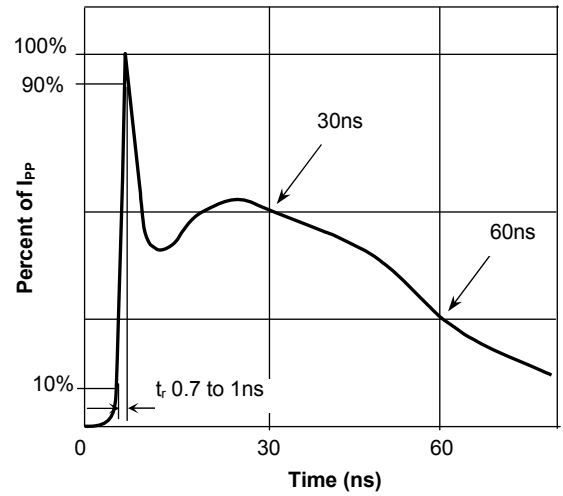

**Product Dimensions**

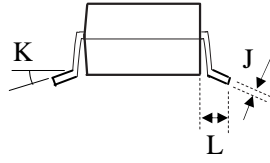
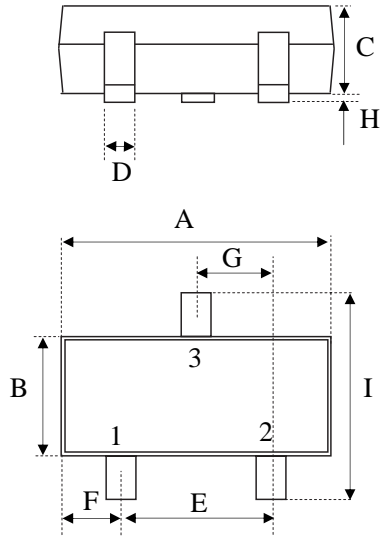

Dim	millimeters	
	min	max
A	2.80	3.04
B	1.20	1.40
C	0.89	1.11
D	0.37	0.50
E	1.78	2.04
F	0.45	0.60
G	0.89	1.02
H	0.013	0.100
I	2.10	2.50
J	0.085	0.177
K	0°	10°
L	0.45	0.60

**Package Information**

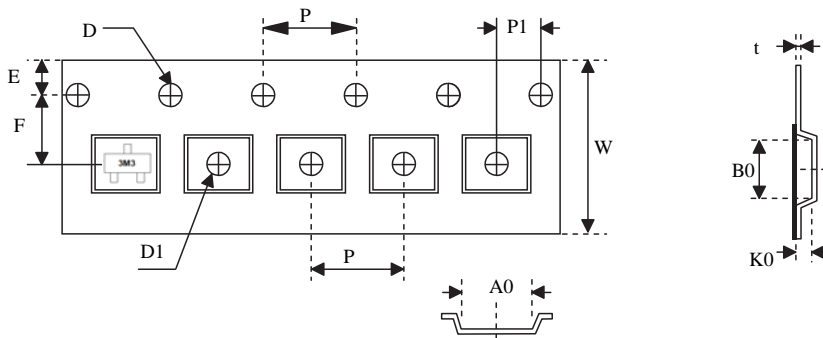

Unit:mm

A0	B0	K0	D1	D	E	F	W	P	P1	t
3.15±0.10	2.77±0.10	1.22±0.10	0.95~1.10	1.50~1.60	1.75±0.10	3.50±0.05	7.90~8.3	4.00±0.10	2.00±0.05	0.22±0.40

**Marking**

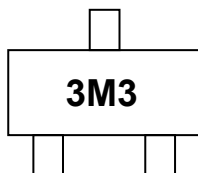

**Order Information**

Device	Package	Net Weight	Carrier	Quantity	HSF Status
SES3V3T23-3	SOT-23	0.0090g	Tape & Reel	3000pcs	RoHS compliant