

Features

- Small Body Outline Dimensions
- Protects one I/O line
- Working Voltage: 12V
- Low Leakage Current
- Response Time is Typically < 1 ns
- IEC 61000-4-2 (ESD) ±32kV (air), ±30kV (contact) IEC 61000-4-4 (EFT) 40A (5/50ns)
IEC 61000-4-5 (Lighting) 5A (8/20µs)

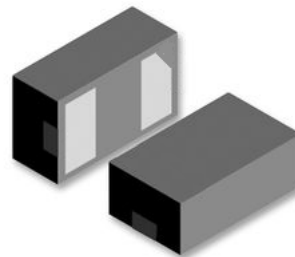

DFN1006

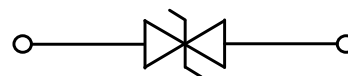

Schematic Diagram

Absolute Maximum Ratings

($T_A=25^{\circ}\text{C}$ unless otherwise specified)

Parameter	Symbol	Value	Unit
Peak Pulse Power ($t_p = 8/20\mu\text{s}$)	P_{PP}	150	W
Peak Pulse Current ($t_p = 8/20\mu\text{s}$)	I_{FP}	5	A
Junction Temperature	T_J	-55 to +125	°C
Storage Temperature	T_{STG}	-55 to +150	

Electrical Characteristics ($T_A=25^{\circ}\text{C}$ unless otherwise specified)

Parameter	Symbol	Test Condition	Value			Unit
			Min	Typ.	Max	
Reverse standoff voltage	V_{RWM}		-	-	12.0	V
Breakdown voltage	V_{BR}	$I_T=1\text{mA}$	13.3	-	-	V
Reverse leakage current	I_R	$V_{RWM}=12\text{V}$	-	-	200	nA
Peak Pulse Current	I_{PP}	$t_p=8/20\mu\text{s}$	-	-	5	A
Clamping voltage	V_C	$I_{PP}=1\text{A}, t_p=8/20\mu\text{s}$	-	-	20	V
Clamping voltage	V_C	$I_{PP}=5\text{A}, t_p=8/20\mu\text{s}$	-	-	26	V
Junction capacitance	C_J	$V_R=0\text{V}, f=1\text{MHz}$	-	9	15	pF

Note:

1. ESD Pulse Waveform according to IEC 61000-4-2 , see Table1 and Figure1
2. ESD tests Setup see Figure2.
3. The clamping Voltage data is taken with a 100x attenuator.

Ratings and Characteristic Curves ($T_A = 25^\circ\text{C}$ unless otherwise noted)

Figure 1: Peak Pulse Power vs. Pulse Time

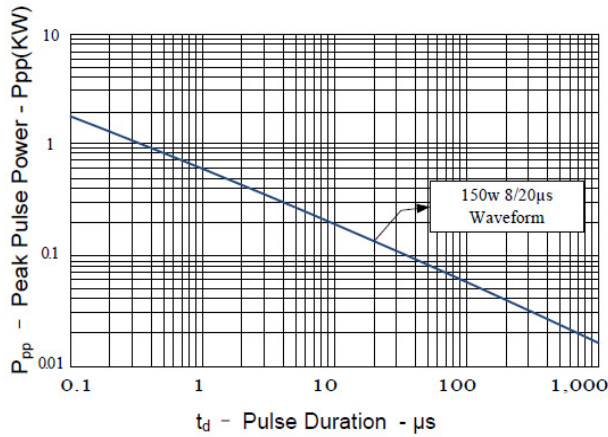

Figure 2: Power Derating Curve

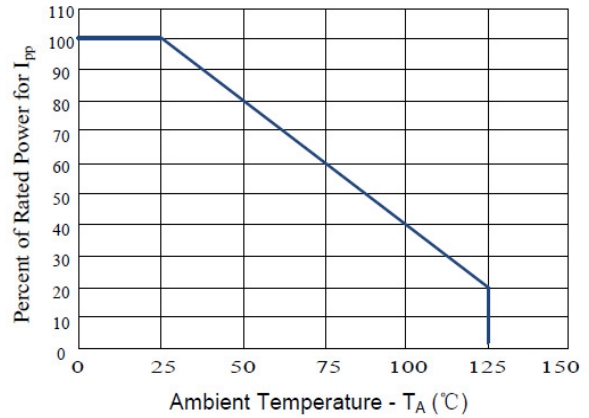

Figure 3: Clamping Voltage vs. Peak Pulse Current

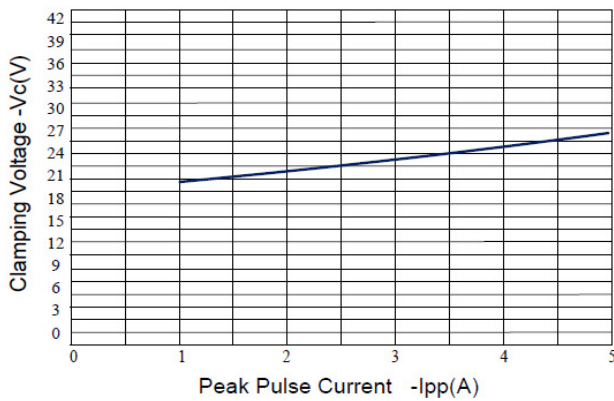

Figure 4: Normalized Junction Capacitance vs. Reverse Voltage

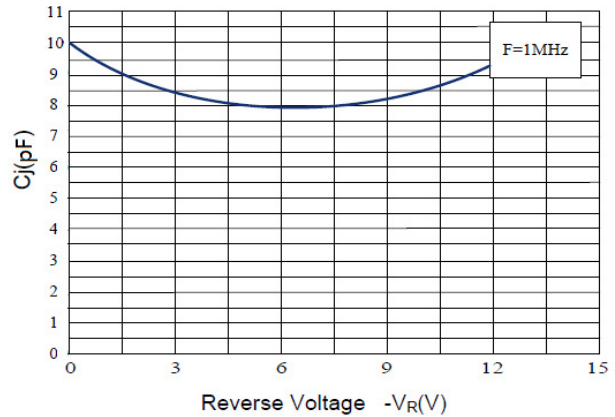

Figure 5: 8/20μs Pulse Waveform

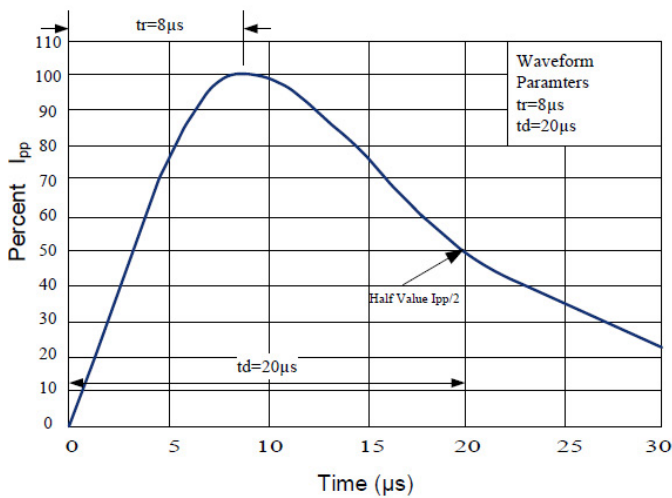
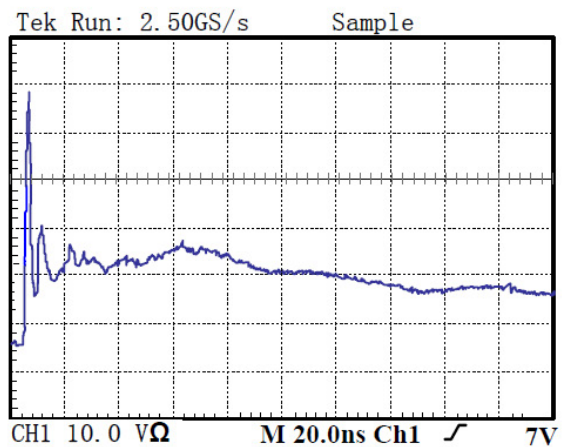
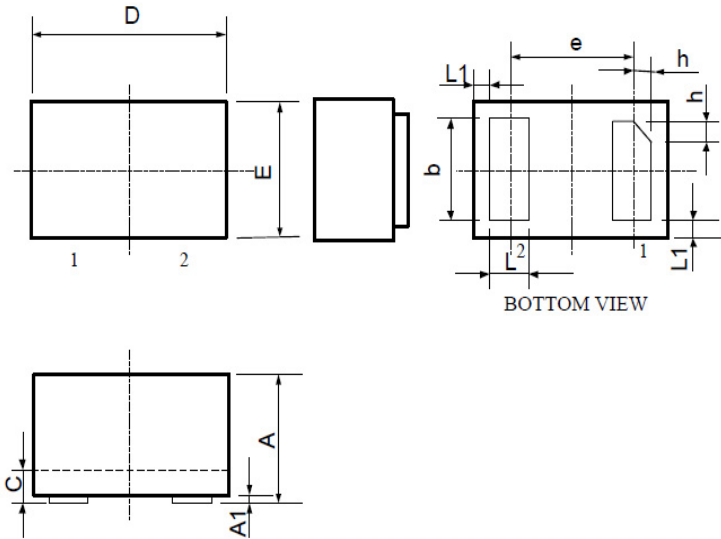

Figure 6: ESD Clamping(8kV Contact per IEC 61000-4-2)



Package Outline Dimensions DFN1006



SYMBOL	Milimeter		
	Min.	Typ.	Max.
A	0.45	0.50	0.55
A1	0	0.02	0.05
b	0.45	0.50	0.55
C	0.12	0.15	0.18
D	0.95	1.00	1.05
e	0.65 Bsc.		
E	0.55	0.60	0.65
L	0.20	0.25	0.30
L1	0.05 Ref.		
h	0.04	0.12	0.17

Recommended Pad Layout

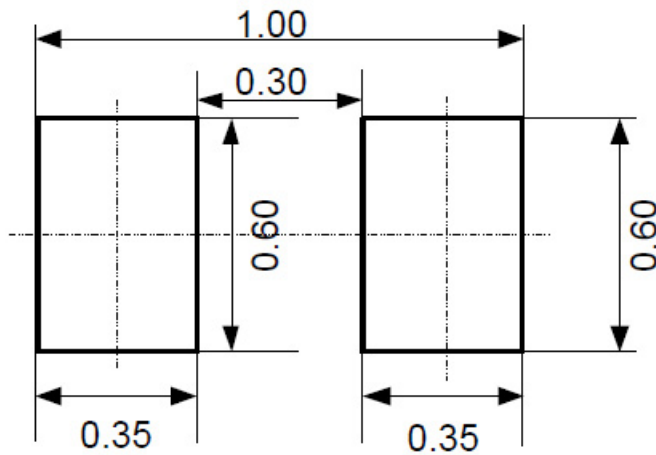

Ordering Information

Device	Package	Carrier	Quantity	HSF Status
GSEZ12B090	DFN1006	Tape & Reel	10,000pcs / Reel	RoHS compliant