

Descriptions

The component consists of two high-performance ceramic PTCs mounted in a lead-frame for (SMD) direct soldering on a printed-circuit board (PCB) or substrate. The ceramic PTCs are soldered to the lead frame by a reflow process, during which the solder layer is melted to the metallized ceramic surface using a low residue flux. This structure can hold the low matched resistance in a loop. The component is in accordance to RoHS.

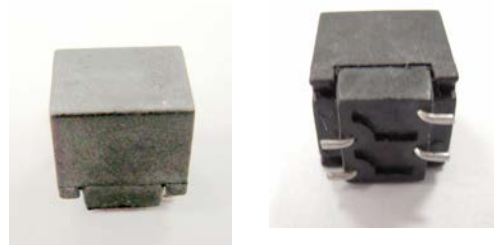

Features

- Very small footprint, allowing to increase the number of lines per PCB
- Matched pairs in one component, significantly reducing the assembly time
- Limited height and weight, used on high speed pick-and-place circuit assembly
- Flat pick-up ceramic area for easy placement
- Four spaced terminations for heat flow regulation and improved mechanical stability
- RoHS compliant and suitable for Pb-baring and Pb-free reflow soldering
- Compliant with ITU-T K.20Enhance
- Enhanced level lightning surges (4KV, 10/700 μ S)
- Enhanced power induction (600 V, 1 A, 1S)
- Power contact criteria B (600 V, 60A, 5S.)

Applications

Dual SMD PTC are typically used as the principle overcurrent protectors in Telecom product interface circuit.

- Transmission equipment such as Central Office linecard, DLC linecard, NGN linecard, MSAN linecard, FTTx linecard ...
- Customer Premises Equipment (CPE) such as IAD-VoDSL, ATA, STB, VoIPGW, VoCable, Wireless VoIP router, PC telephony card ...
- PBX's and other switches
- Primary protection including main distribution frames, building entrance equipment and station protection modules.

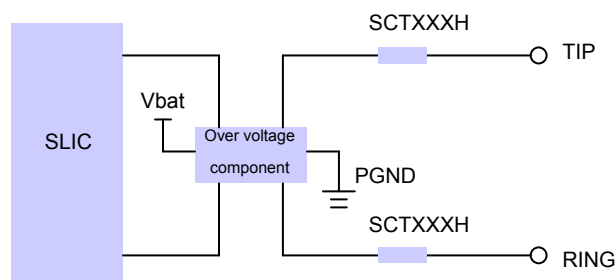

Typical VoIP SLIC Protection Circuit

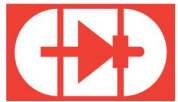

SCT500H

Twin SMD Ceramic PTC Thermistor

Basic reference data

PARAMETER	VALUE	UNIT
Rated voltage (RMS)	230	V
Maximum voltage (RMS)	450	V
Operating temperature range V=0	-40 to +110	°C
Operating temperature range V=V _{max}	0 to +70	°C
Weight	~1.0	g
Resistance	50 ± 10%	Ω
The initial resistance difference of Two PTC thermistors in one house	1.0	Ω

Electrical Characteristics

No.	ITEM	Min.	Typ.	Max.	Unit
1	Rated zero power resistance (25°C)	45	50	55	Ω
2	The initial resistance difference of two PTC thermistor in one device at 25°C			1.0	Ω
3	Hold current at 25±2°C			90	mA
4	Hold current at 70±2°C			50	mA
5	Operating current (230Vac,@25°C)	200			mA
6	V _{Fault} :Security failure voltage (with 10R loading)			600	V _{rms}
7	R _{HV} :Minimum equivalent resistance (@ 10/700 uS, 4 KV / 40 Ω)	18			Ω
8	V _{surge} :Lightning surge test (10/700 uS, R _s = 40 Ω) ^{1) 2)}			4.2KV	Vp
9	I _{Smax} :Overcurrent withstanding (@25°C, 450Vac) ^{1) 2)}			9	A
10	Recovery time (@25°C)			90	S
11	Operating heat capacity (@25°C, 230Vac)	40			J
12	Power induction test: 600V _{AC} , 3A, @25°C ³⁾	10			A ² S
13	Power contact test: 600V _{AC} , 60A, @25°C ⁴⁾	5			S
14	Curie temperature		120		°C

Comments:

- 1) Testing PTC resistance rate <20%.
- 2) Test process, PTC won't happen smoke and flame, flash collaterals, explosion, chipped safety phenomenon,etc.
- 3) PTC without primary protector.
- 4) PTC resistance changes can be more than 20%, but no fireworks/burst etc. No safety phenomenon.

Physical Specifications

Lead material	Tin plated brass
Case material	PPS
Solder heat withstand	IEC-STD 68-2-20,
Lead solderability	EIC60068-2-58
Flammability rating	IEC 695-2-2 Needle Flame Test for 20 s
Storage humidity	Per IPC/JEDEC J-STD-020A Level 2a

Environmental Specifications

Test	Conditions
Dry Hot	85°C, 0V, 1000 hours
Dry Cold	-40°C, 0V, 1000 hours
Humidity aging	40°C, 95% RH, 0V, 1000 hours
Thermal shock	85°C, -40°C (10 times)
Solvent resistance	MIL-STD-202, Method 215F

Standards

- Housing material according to UL94-V0
- Climatic category acc. to IEC 68-1 40/125/56
- Compliant with ITU-T K21

Product Dimensions (mm)

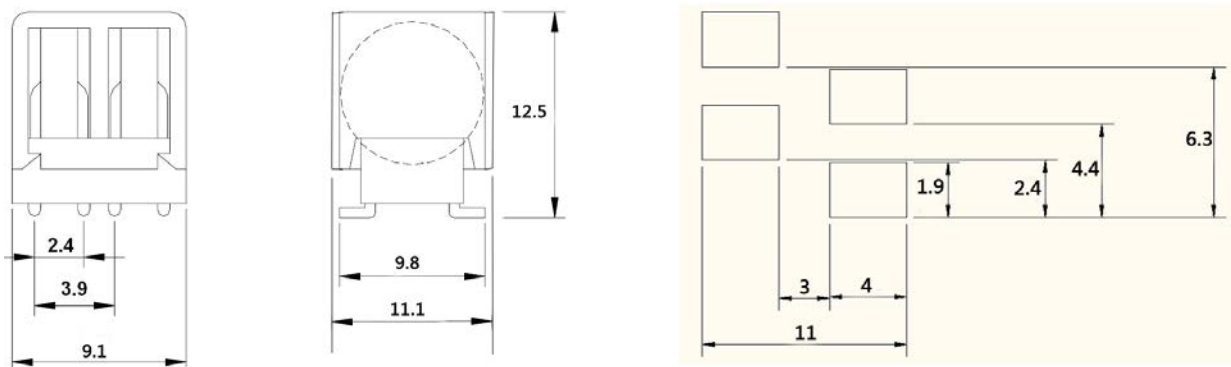

Product Marking

SCT

500H

Reflow Soldering and Rework Recommendations

Reflow Solder Curve

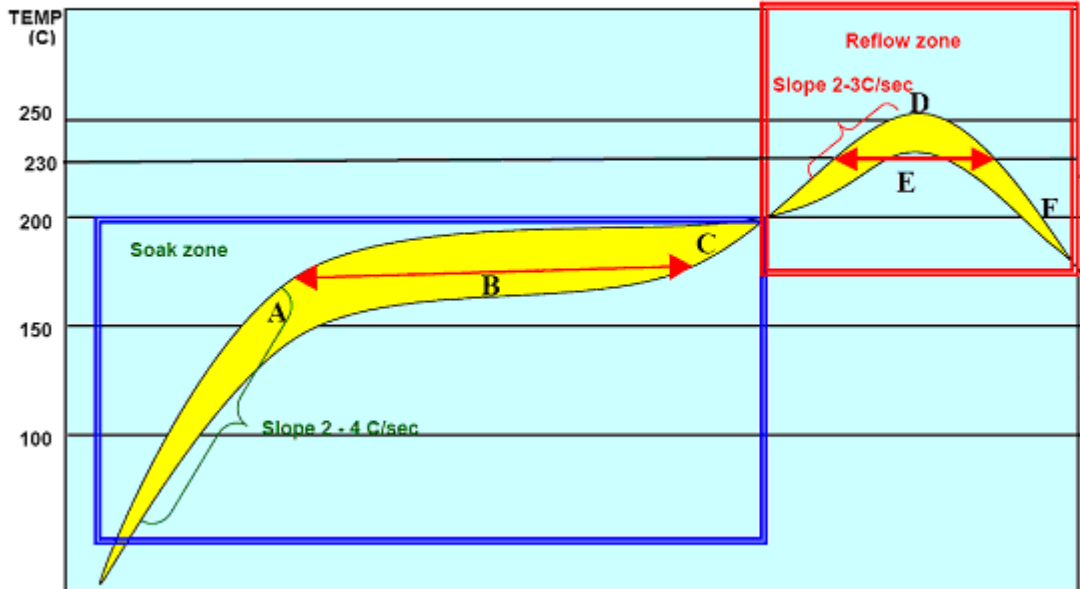

Item	Process	Description	Reach Temp.	Time or Rate
A	Soak Start	From ambient to soak temperature and soak start	150°C - 180°C	2°C - 4°C / sec
B	Soak time	Soak time	---	60s - 120s
C	Soak end	Soak end	180°C - 200°C	---
D	Peak Temp.	From soak temperature to Peak temperature	260°C	2°C - 3°C / sec
E	Time above	Main heating time	230°C - 260°C	40s - 60s
F	Cooling	From main heating temperature to 100°C	100°C	Max. 4°C / sec

Notes:

1* Peak temperature can be high to 260°C, and the recommendation time is as below

- at 230°C 40s ~ 60s
- at 240°C 30s ~ 40s
- at 260°C ~ 3s

2* Recommended reflow methods: IR, Vapor phase oven, hot air oven, wave solder.

3* Devices can be cleaned using standard industry methods and solvents.

4* Component can withstand 270°C 10 sec.

5* If reflow temperatures exceed the recommended profile, devices may not meet the performance requirements.

Storage

The production should be in the environment of good ventilation. The indoor temperature is -40°C~+55°C, and the relative humidity ≅85% (at 25° , without acid, alkali and other harmful impurity).

Package Information

Package	Reel QTY	Box QTY	Component Weight	Net Weight Per Box	Gross Weight/Per Box	Box Outline
	PCS	PCS	g	Kg	Kg	mm
Tape	250	2500				

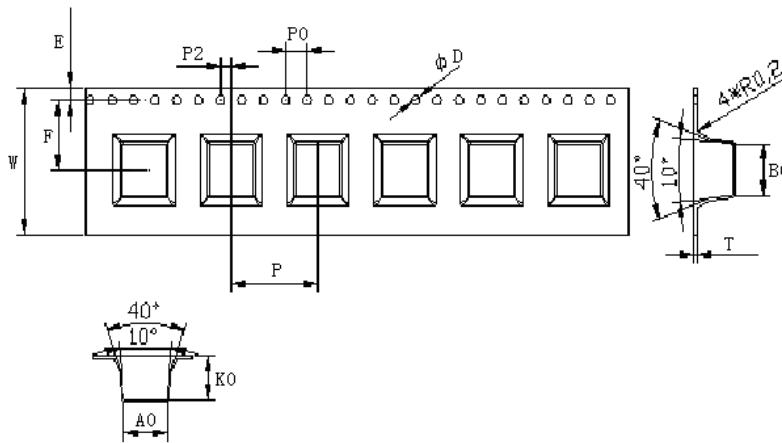

ITEM	DIM
W	24.00 ± 0.5
A0	11.15 ± 0.2
B0	9.3 ± 0.2
K0	12.60 ± 0.2
E	1.75 ± 0.1
F	11.50 ± 0.1
P	20.00 ± 0.1
P0	4.00 ± 0.1
P2	2.00 ± 0.1
D	∅1.50 ± 0.1
T	0.50 ± 0.1

Reel packing for 24-mm tape

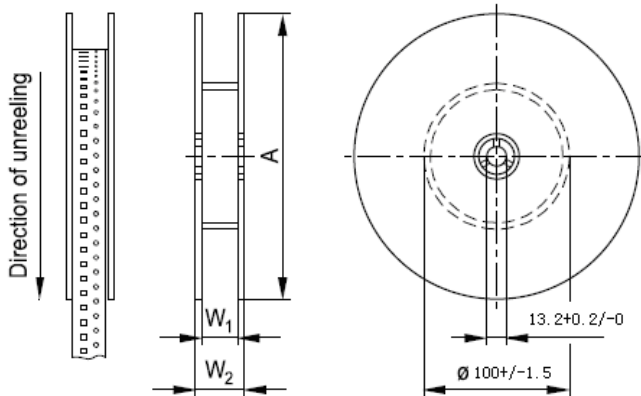

24-mm tape

Dimension	330 -mm reel
A	330 -2/+0
W ₁	24.4 min.
W ₂	30.4 max.