

Main Product Characteristics

$V_{(BR)DSS}$	100V
$R_{DS(on)MAX}$	28mΩ@10V
	38mΩ@4.5V
I_D	28 A

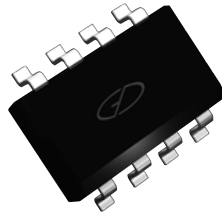

SOP-8

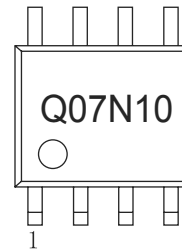

Marking and Pin Assignment

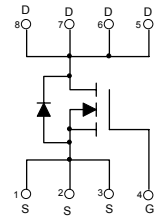

Schematic Diagram

Features and Benefits

- Advanced MOSFET process technology
- Ideal for battery operated systems, load switching, power converters and other general purpose applications
- Low on-resistance with low gate charge
- Fast switching and reverse body recovery



Description

The SSFQ07N10 utilizes the latest techniques to achieve high cell density and low on-resistance. These features make this device extremely efficient and reliable for use in high efficiency switch mode power supply and a wide variety of other applications.

Absolute Maximum Ratings (T_A=25°C unless otherwise specified)

Parameter	Symbol	Value	Unit
Drain-Source Voltage	V _{DS}	100	V
Gate-Source Voltage	V _{GS}	±20	V
Continuous Drain Current	I _D	7	A
Pulsed Drain Current	I _{DM}	28	A
Single Pulsed Avalanche Energy	E _{AS} ⁽¹⁾	16	mJ
Power Dissipation	P _D	1.4	W
Thermal Resistance from Junction to Ambient	R _{θJA}	89	°C/W
Junction Temperature	T _J	150	°C
Storage Temperature Range	T _{STG}	-55 to +150	°C
Lead Temperature for Soldering Purposes(1/8" from case for 10s)	T _L	260	°C

(1).E_{AS} condition: V_{DD}=25V,L=0.1mH, R_G=25Ω, Starting T_J = 25°C

Electrical Characteristics ($T_A=25^{\circ}\text{C}$ unless otherwise specified)

Parameter	Symbol	Test Condition	Min	Typ	Max	Unit
Off Characteristics						
Drain-Source Breakdown Voltage	$V_{(BR)DSS}$	$V_{GS} = 0V, I_D = 250\mu A$	100	---	---	V
Zero Gate Voltage Drain Current	I_{DSS}	$V_{DS} = 80V, V_{GS} = 0V$	---	---	1	μA
Gate-Body Leakage Current	I_{GSS}	$V_{DS} = 0V, V_{GS} = \pm 20V$	---	---	± 100	nA
On Characteristics (note 1)						
Gate-Threshold Voltage	$V_{GS(th)}$	$V_{DS} = V_{GS}, I_D = 250\mu A$	1.2	---	3.0	V
Static Drain-Source On-State Resistance	$R_{DS(on)}$	$V_{GS} = 10V, I_D = 7A$	---	25	28	m Ω
		$V_{GS} = 4.5V, I_D = 5A$	---	30	38	m Ω
Forward Transconductance	g_{fs}	$V_{DS} = 5V, I_D = 7A$	---	22	---	S
Dynamic Characteristics						
Input Capacitance	C_{iss}	$V_{DS} = 15V, V_{GS} = 0V,$ $f = 1MHz$	---	1848	---	pF
Output Capacitance	C_{oss}		---	276	---	
Reverse Transfer Capacitance	C_{rss}		---	97.9	---	
Switching Characteristics						
Total Gate Charge	Q_g	$V_{DS} = 80V, V_{GS} = 10V,$ $I_D = 7A$	---	31.9	---	nC
Gate-Source Charge	Q_{gs}		---	5.5	---	
Gate-Drain Charge	Q_{gd}		---	8.8	---	
Turn-On Delay Time	$t_{d(on)}$	$V_{DD} = 50V, I_D = 7A,$ $V_{GS} = 10V, R_G = 3.3\Omega,$ $R_L = 6.7\Omega$	---	11.4	---	ns
Turn-On Rise Time	t_r		---	27.2	---	
Turn-off Delay Time	$t_{d(off)}$		---	34.7	---	
Turn-off Fall Time	t_f		---	16.6	---	
Gate Resistance	R_g	$f = 1MHz, V_{DS} = 0V,$ $V_{GS} = 0V,$	---	1.9	---	Ω
Drain-Source Diode Characteristics						
Drain-Source Diode Forward Voltage (note 1)	V_{SD}	$V_{GS} = 0V, I_S = 1A$	---	---	1.2	V
Continuous Drain-Source Diode Forward Current	I_S		---	---	7	A
Pulsed Drain-Source Diode Forward Current	I_{SM}		---	---	28	A

Notes:

1. Pulse Test : Pulse Width $\leq 300\mu s$, duty cycle $\leq 2\%$.

Typical Electrical and Thermal Characteristic Curves

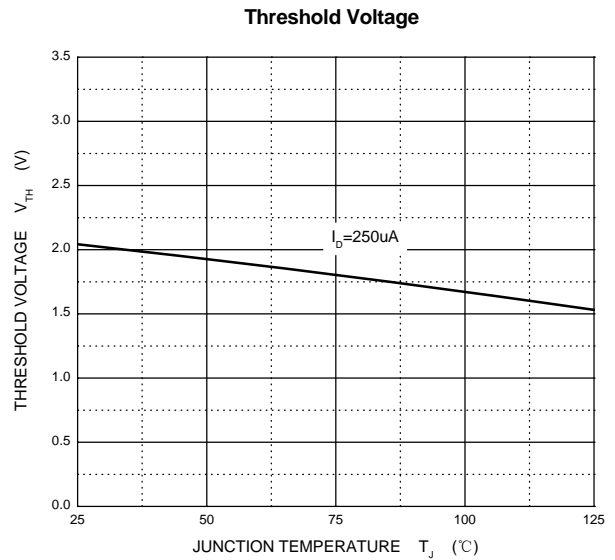
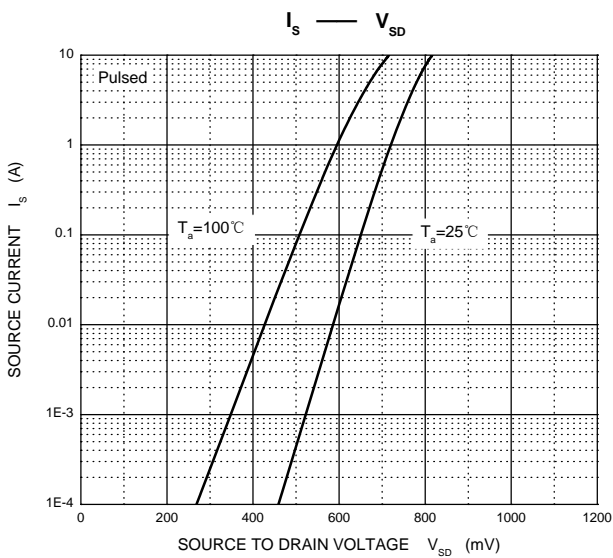
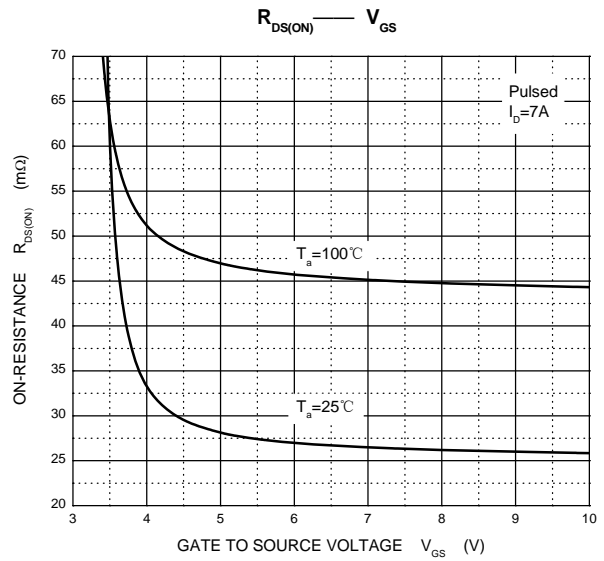
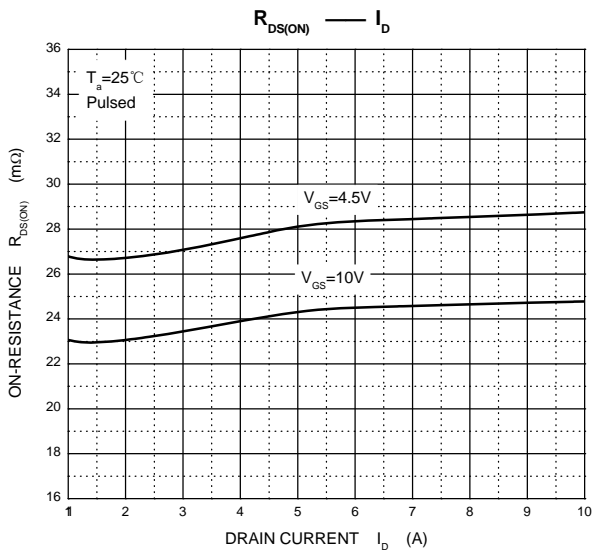
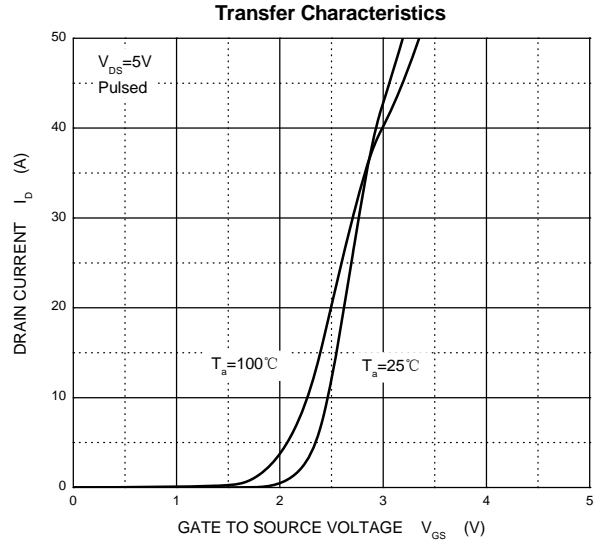
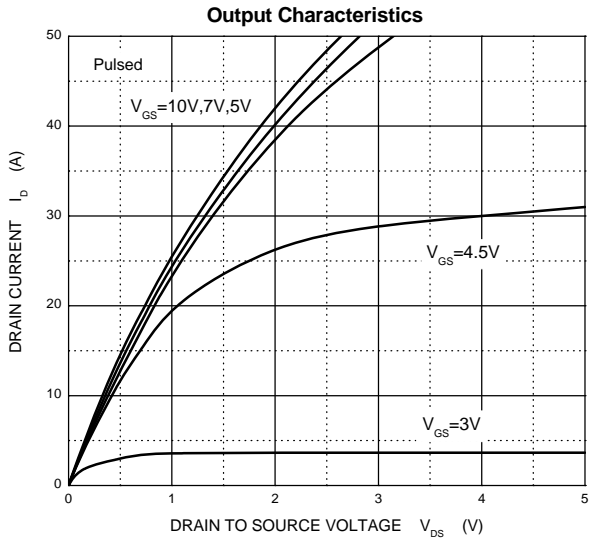

Package Outline Dimensions

SOP-8

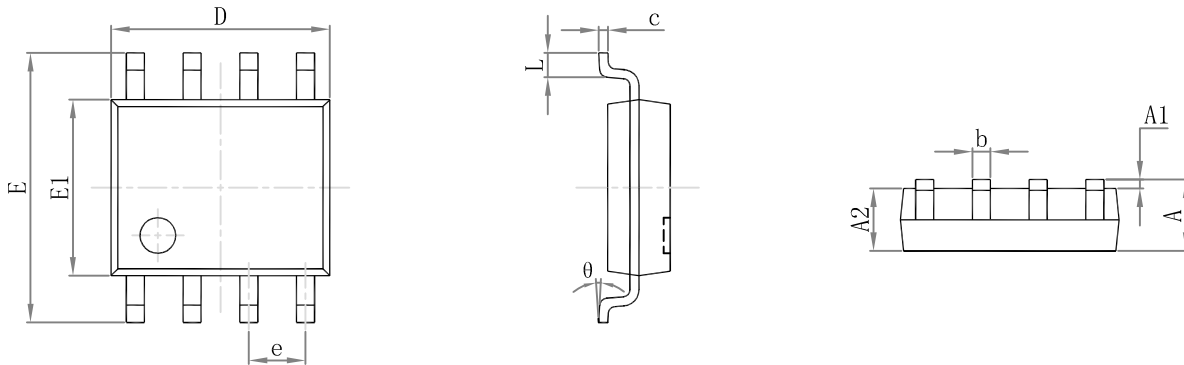

Symbol	Dimensions In Millimeters		Dimensions In Inches	
	Min	Max	Min	Max
A	1.350	1.750	0.053	0.069
A1	0.100	0.250	0.004	0.010
A2	1.350	1.550	0.053	0.061
b	0.330	0.510	0.013	0.020
c	0.170	0.250	0.007	0.010
D	4.800	5.000	0.189	0.197
e	1.270 (BSC)		0.050 (BSC)	
E	5.800	6.200	0.228	0.244
E1	3.800	4.000	0.150	0.157
L	0.400	1.270	0.016	0.050
θ	0°	8°	0°	8°

Suggested Pad Layout

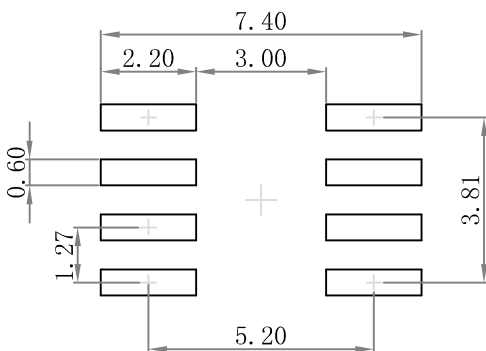

Note:
 1. Controlling dimension: in millimeters.
 2. General tolerance: ± 0.05mm.
 3. The pad layout is for reference purposes only.