

Main Product Characteristics

$V_{(BR)DSS}$	$R_{DS(on) \max}$	I_D
30V	8Ω@4V	100mA
	13Ω@2.5V	

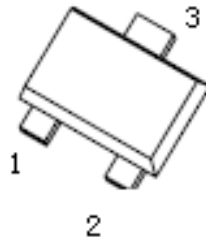

SOT-723

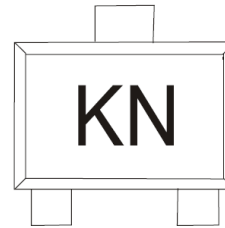

Marking

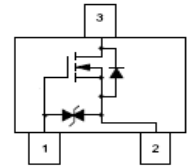

1. GATE
2. SOURCE
3. DRAIN

Schematic Diagram

Features

- Low on-resistance
- Fast switching
- Ideal for portable applications



Absolute Maximum Ratings ($T_A=25^\circ\text{C}$ unless otherwise specified)

Parameter	Symbol	Value	Unit
Drain-source voltage	V_{DS}	30	V
Gate-source voltage	V_{GS}	±20	
Continuous drain current	I_D	±100	mA
Power dissipation	P_D	0.15	W
Thermal resistance from junction to ambient	$R_{\theta JA}$	833	$^\circ\text{C/W}$
Junction temperature	T_J	150	$^\circ\text{C}$
Storage temperature	T_{stg}	-55 ~ +150	

* $P_w \leq 10\mu\text{s}$, Duty cycle $\leq 1\%$

Electrical Characteristics ($T_A=25^\circ\text{C}$ unless otherwise specified)

Parameter	Symbol	Test Condition	Min	Typ	Max	Unit
Drain-source breakdown voltage	$V_{(BR)DSS}$	$V_{GS} = 0V, I_D = 10\mu\text{A}$	30			V
Gate-source leakage current	I_{GSS}	$V_{DS} = 0V, V_{GS} = \pm 20V$			±2	μA
Zero gate voltage drain current	I_{DSS}	$V_{DS} = 30V, V_{GS} = 0V$			1.0	μA
Gate threshold voltage	$V_{GS(th)}$	$V_{DS} = 3V, I_D = 100\mu\text{A}$	0.8		1.5	V
Static drain-source on-state resistance	$R_{DS(on)}$	$V_{GS} = 4V, I_D = 10\text{mA}$		5	8	Ω
		$V_{GS} = 2.5V, I_D = 1\text{mA}$		7	13	
Forward transconductance	g_{FS}	$V_{DS} = 3V, I_D = 10\text{mA}$	20			mS
Input capacitance	C_{iss}	$V_{DS} = 5V, V_{GS} = 0V, f = 1\text{MHz}$		13		pF
Output capacitance	C_{oss}			9		
Reverse transfer capacitance	C_{rss}			4		
Turn-on delay time	$t_{d(on)}$	$V_{GS} = 5V, V_{DD} = 5V, I_D = 10\text{mA}$ $R_L = 500\Omega, R_G = 10\Omega$		15		ns
Rise time	t_r			35		
Turn-off delay time	$t_{d(off)}$			80		
Fall time	t_f			80		

Typical Characteristic Curves

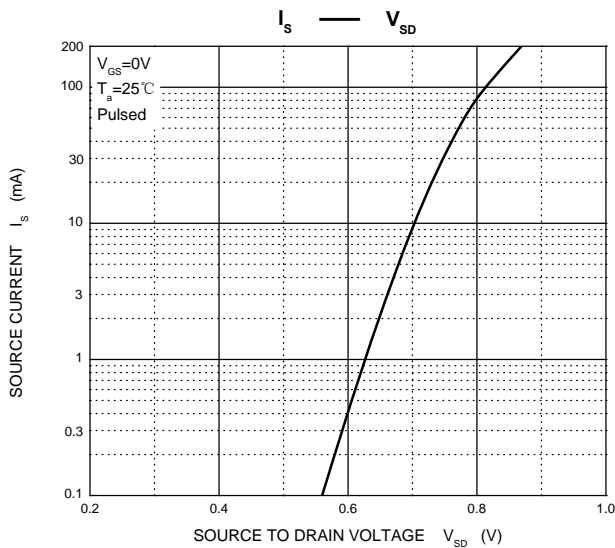
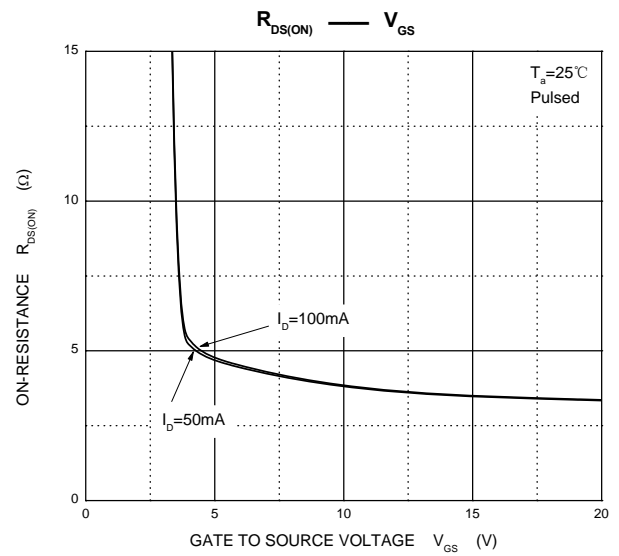
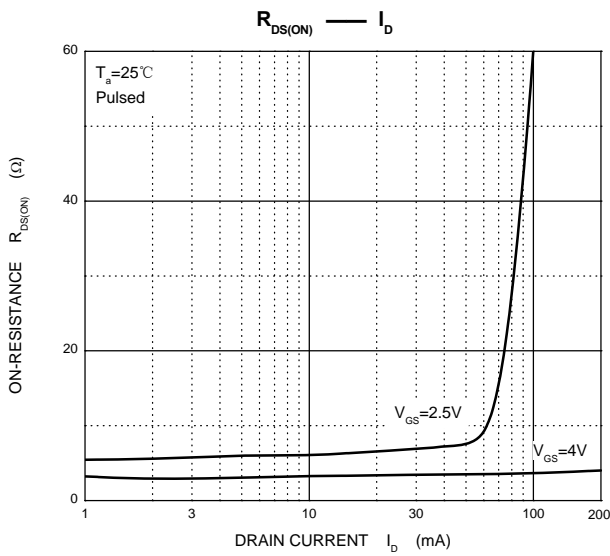
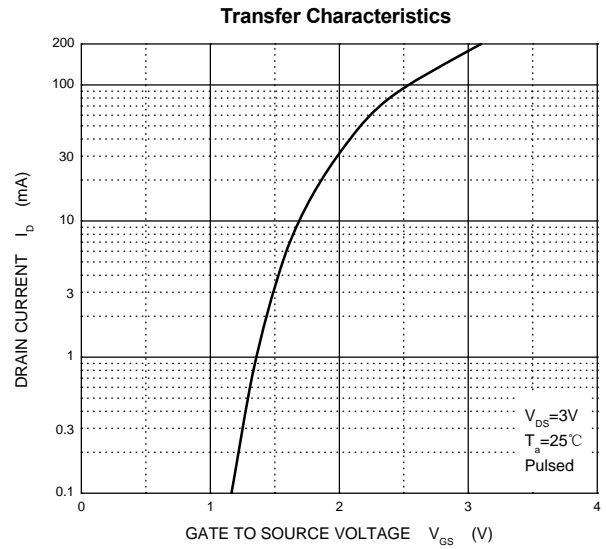
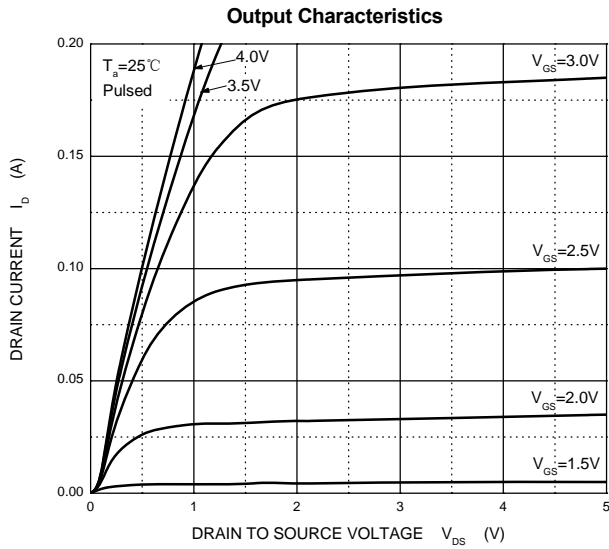

Package Outline Dimensions SOT-723

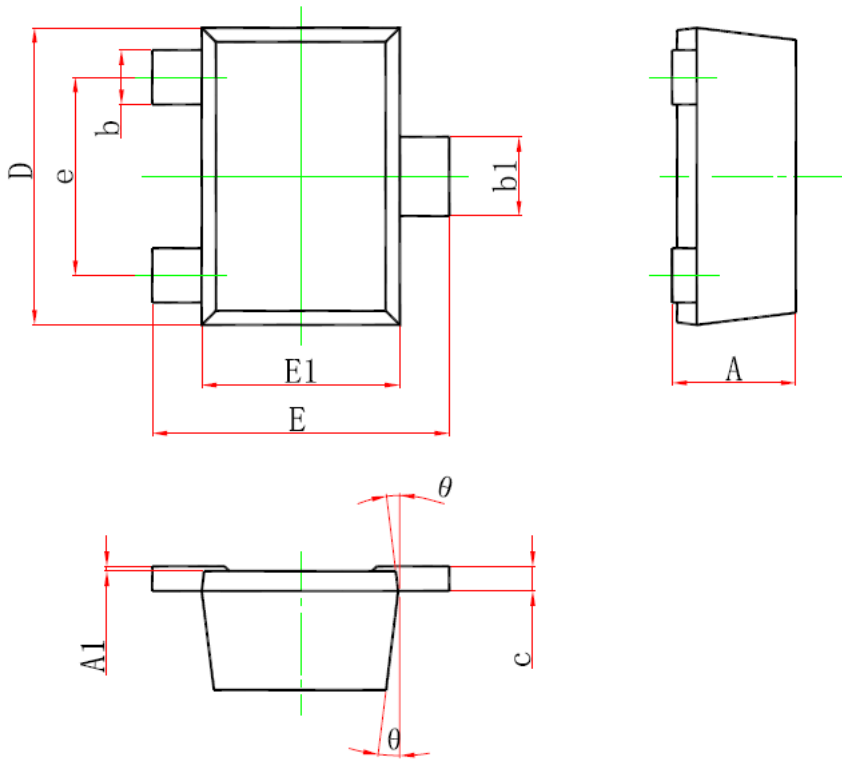

Symbol	Dimensions In Millimeters		Dimensions In Inches	
	Min.	Max.	Min.	Max.
A	0.430	0.500	0.017	0.020
A1	0.000	0.050	0.000	0.002
b	0.170	0.270	0.007	0.011
b1	0.270	0.370	0.011	0.015
c	0.080	0.150	0.003	0.006
D	1.150	1.250	0.045	0.049
E	1.150	1.250	0.045	0.049
E1	0.750	0.850	0.030	0.033
e	0.800TYP.		0.031TYP.	
θ	7° REF.		7° REF.	