

Features

- 500 Watts peak pulse power ($t_P = 8/20\mu s$)
- SOT-23 package
- Low capacitance
- Fast response time, typically $< 1\text{ ns}$
- Excellent clamping voltage
- Low leakage current
- IEC 61000-4-2 $\pm 15\text{kV}$ (Air) ESD protection
- IEC 61000-4-2 $\pm 8\text{kV}$ (Contact) ESD protection
- IEC 61000-4-5 24A (8/20 μs) Lightning protection
- RoHS compliant

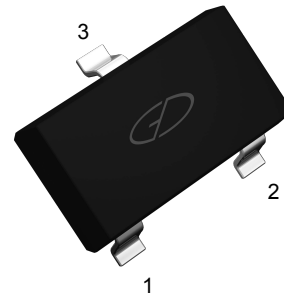

Package: SOT-23

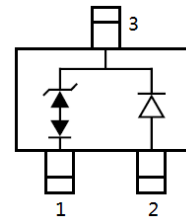

Schematic Diagram

Applications

- Cellular Handsets and Accessories
- Portable Electronics
- Fire wire
- Servers, Notebooks, and Desktop Pcs
- LAN/WAN equipment
- High speed data lines

Absolute Maximum Ratings

($T_A=25^\circ\text{C}$ unless otherwise specified)

Rating	Symbols	Value	Units
Peak Pulse Power ($t_P=8/20\mu S$)	P_{PP}	500	W
Peak Pulse Current ($t_P=8/20\mu S$)	I_{PP}	24	A
Operating Temperature	T_J	-55 to +150	$^\circ\text{C}$
Storage temperature	T_{STG}	-50 to +150	$^\circ\text{C}$

Electrical Characteristics

($T_A=25^\circ\text{C}$ unless otherwise specified)

Parameter	Symbols	Conditions	Min	Typ	Max	Units
Reverse stand-off Voltage	V_{RWM}	-	-	-	2.8	V
Reverse Breakdown Voltage	V_{BR}	$I_T=1\text{mA}$	3	4	-	V
Reverse Leakage Current	I_R	$V_{RWM}=2.8\text{V}$	-	-	1	μA
Clamping Voltage	V_C	$I_{PP}=5\text{A}, T_P=8/20\mu S$	-	-	8.5	V
Clamping Voltage	V_C	$I_{PP}=24\text{A}, T_P=8/20\mu S$	-	-	21	V
Junction Capacitance	C_J	$V_R=0\text{V}, f=1\text{MHz}$ (pin1-2)	-	3.5	-	pF

Typical Characteristic Curves

Fig.1 Peak Pulse Power vs Pulse Time

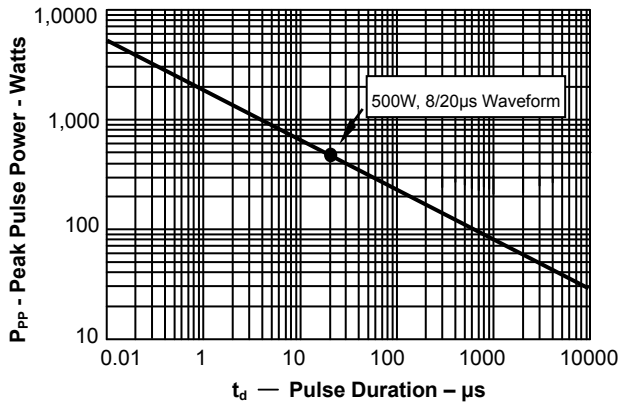

Fig.2 Pulse WaveForm-8/20μs

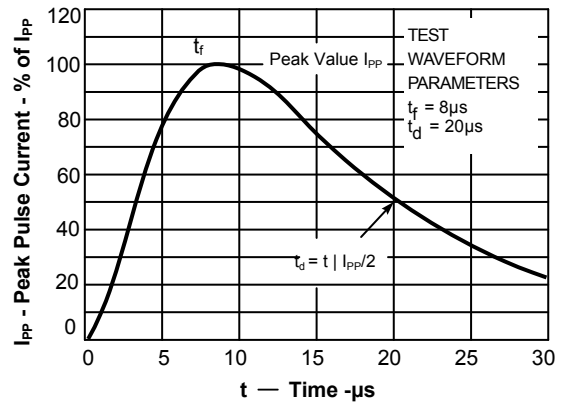

Fig.3 Power Derating Curve

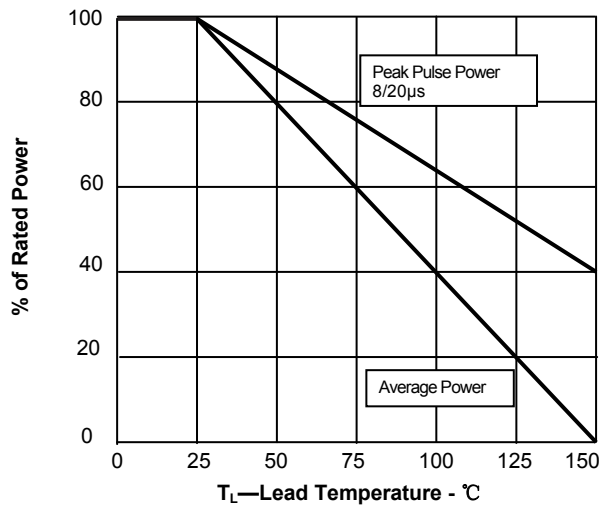
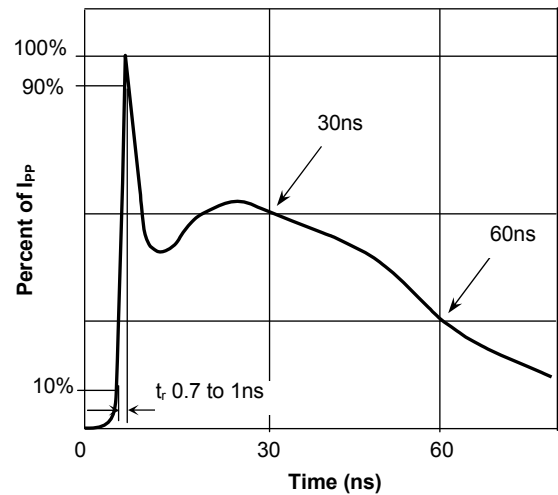
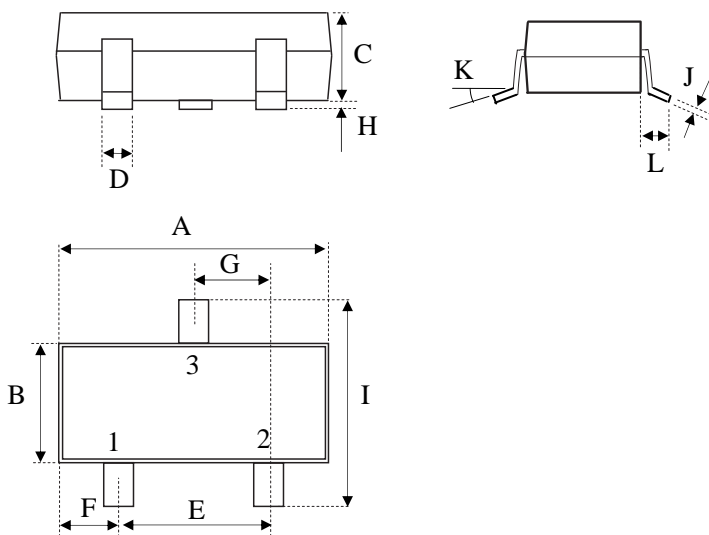

Fig.4 Pulse Waveform-ESD(IEC61000-4-2)



Product Dimensions



Dim	millimeters	
	min	max
A	2.80	3.04
B	1.20	1.40
C	0.89	1.11
D	0.37	0.50
E	1.78	2.04
F	0.45	0.60
G	0.89	1.02
H	0.013	0.100
I	2.10	2.50
J	0.085	0.177
K	0°	10°
L	0.45	0.60

Package Information

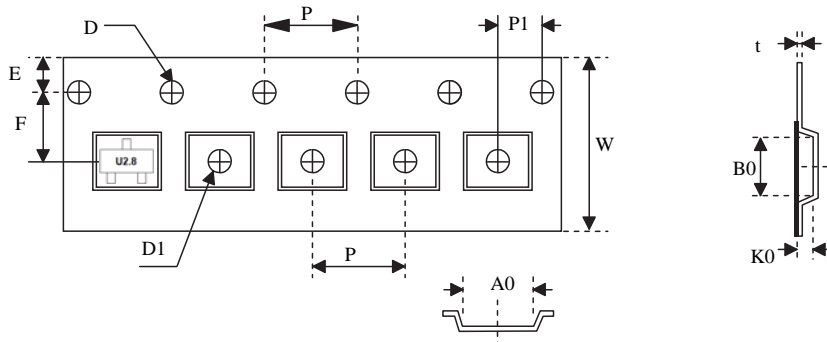

Unit:mm

A0	B0	K0	D1	D	E	F	W	P	P1	t
3.15±0.10	2.77± 0.10	1.22±0.10	0.95~1.10	1.50~1.60	1.75±0.10	3.50±0.05	7.90~8.3	4.00± 0.10	2.00± 0.05	0.22± 0.40

Marking

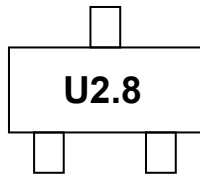

Order Information

Device	Package	Net Weight	Carrier	Quantity	HSF Status
SES2V8T23-3U	SOT-23	0.0090g	Tape & Reel	3000pcs	RoHS compliant